

BOM TABLE				
ITEM NO	PART NO	FILE NAME	DESCRIPTION	QTY
1			CABINET LAV BASE GN3	1
2			CABINET LAV OVERHEAD GN3-	1
3			CABINET TOILET OVERHEAD GN3-	1
4			FILL CABINET	1
5	20064		FILL, WATER	City+Gravity
6	13518		FIRE EXTINGUISHER	1
7	12265		LIGHT, DOME	SURFACE MOUNT
8	14084		LP DETECTOR	1
9	31110		LP TANKS W-TRAY	20#
10			MIRROR	1
11	12492-w/12494-b		MONITOR PANEL, TANKS	3 TANK
12	11978		OUTLET, ELECTRICAL	120V 15A INTERIOR
13	14618		ROOF VENT	12V
14	13849		SEWER HOSE COMP.	1
15	13835		SHOWER NEO ANGLE	NA-34 x 34 NEO ANGLE
16	13798		SINK, OVAL SST 13.25 x 10.5 x 5	1
17	37019		TOILET	1
18	33828		WASTE TANK	H1026 45.5 GAL
19	10545		WATER HEATER, SUBURBAN	6GAL
20	14119		WATER TANK	W0926 42 GAL

ALL LOCATIONS ARE NOMINAL UNLESS CRITICAL DIMENSIONS ARE SPECIFICALLY NOTED

PROPRIETARY AND CONFIDENTIAL:
THE INFORMATION CONTAINED IN THIS DRAWING IS THE SOLE PROPERTY OF THE ALUMINUM TRAILER COMPANY. ANY REPRODUCTION IN PART OR AS A WHOLE WITHOUT THE WRITTEN PERMISSION OF THE ALUMINUM TRAILER COMPANY IS PROHIBITED.



TITLE: **GN3 WALK AROUND BATH**

DRAWN BY: **LDS** DATE: **1/20/15** VIN/PART # **STD PKG** REV. **C**

FILE NAME: GN3

SCALE: 1:18 DATE PRINTED: 10/5/2015 SHEET 1 OF 4

REV.	DESCRIPTION	DATE	APPROVED
C	MOVED HOLDING TANKS	10/5/2015	LDS
B	MODIFIED CAB; ADDED MIRROR	4/10/2015	LDS
A	CHANGED WASTE TANKS TO 45 GAL	1/27/2015	LDS

REVISION TABLE

DWG PATH: X:\Options\GN3 PKG\

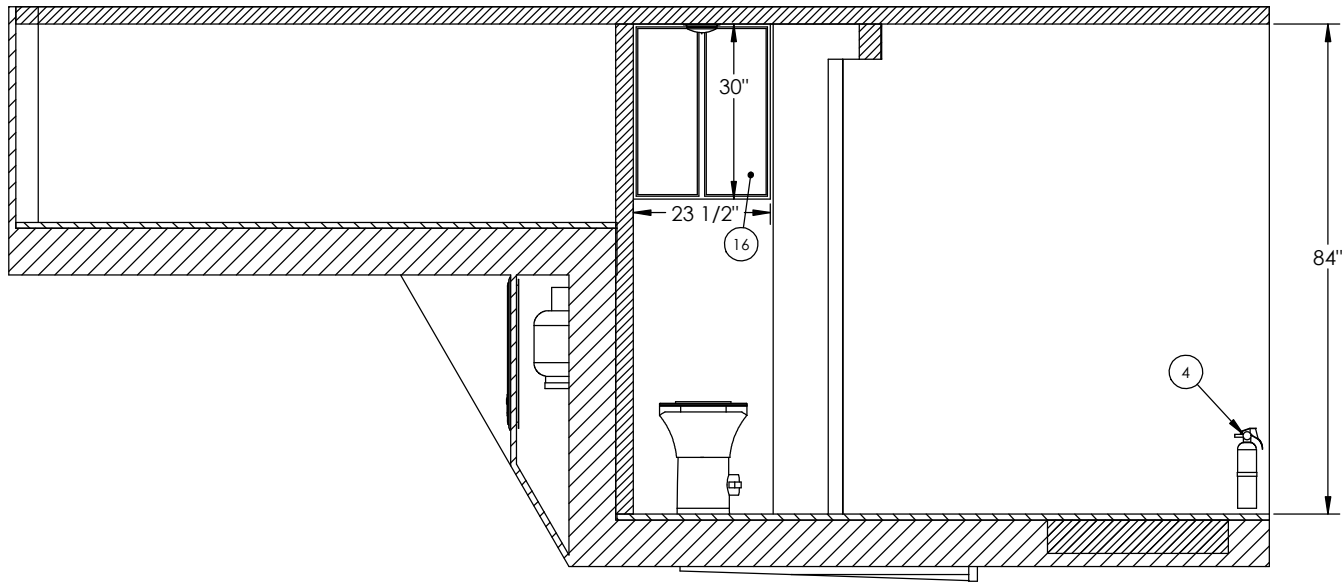

INTERIOR CURB SIDE
SECTION A-A

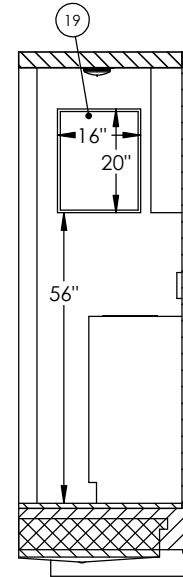

SECTION M-M

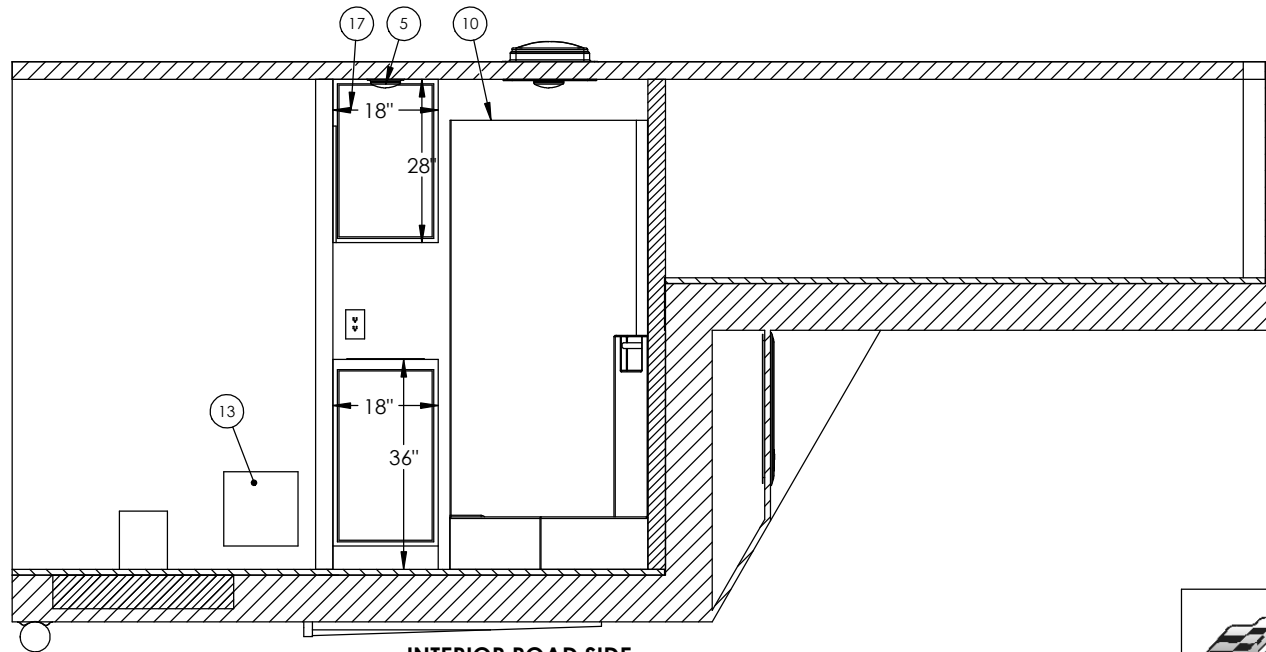

INTERIOR ROAD SIDE
SECTION B-B

		TITLE: GN3 WALK AROUND BATH		
		DRAWN BY: LDS	DATE: 1/20/15	VIN/PART # STD PKG
FILE NAME: GN3				
SCALE: 1:16	DATE PRINTED: 10/5/2015	SHEET 2 OF 4		

TOILET OVERHEAD

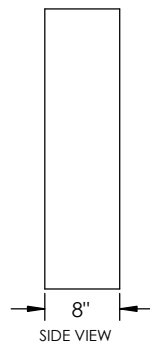
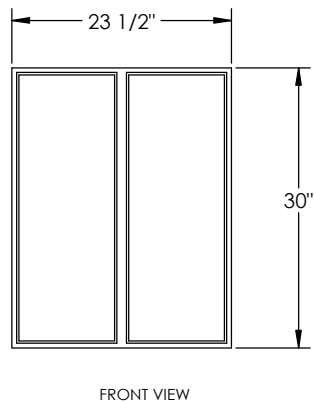
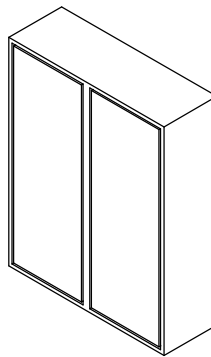
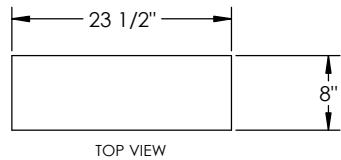

LAV OVERHEAD

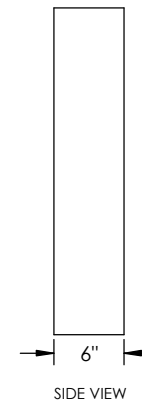
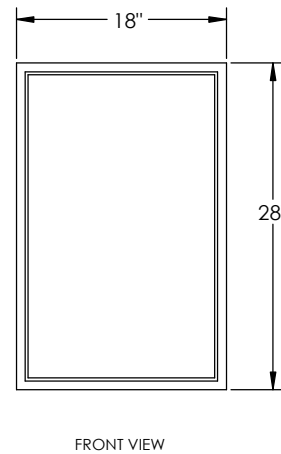
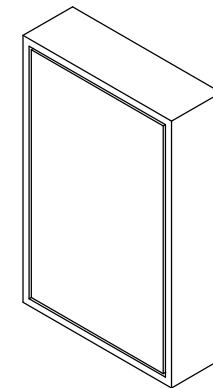

PARTITION WALL

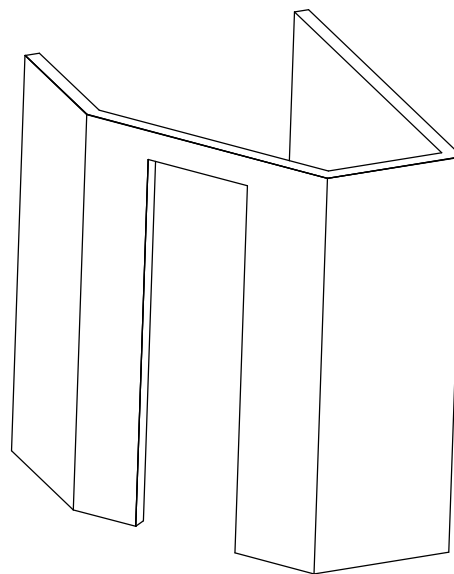
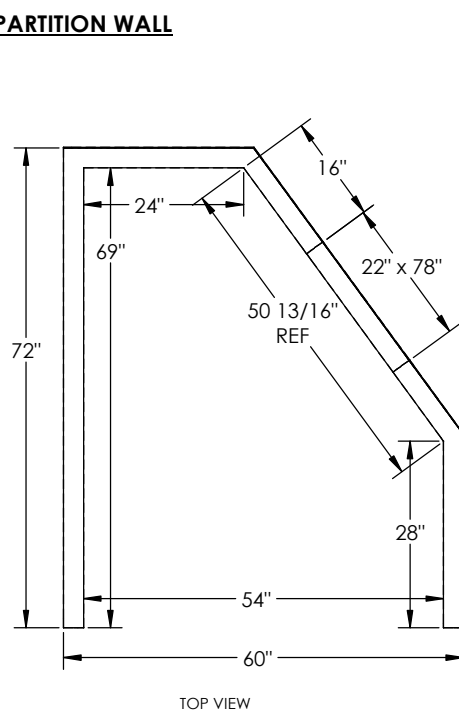

VANITY

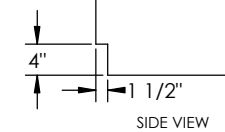
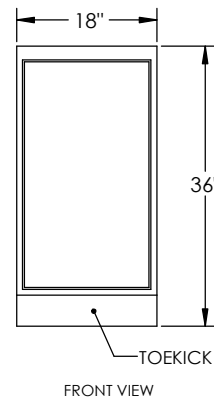
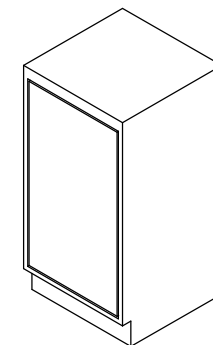
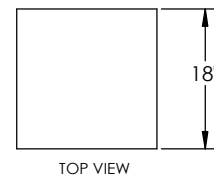

		TITLE: GN3 WALK AROUND BATH		
		DRAWN BY: LDS	DATE: 1/20/15	VIN/PART # STD PKG
FILE NAME: CABINET TOILET OVERHEAD GN3-				
SCALE: 1:14	DATE PRINTED: 10/5/2015	SHEET 3 OF 4		

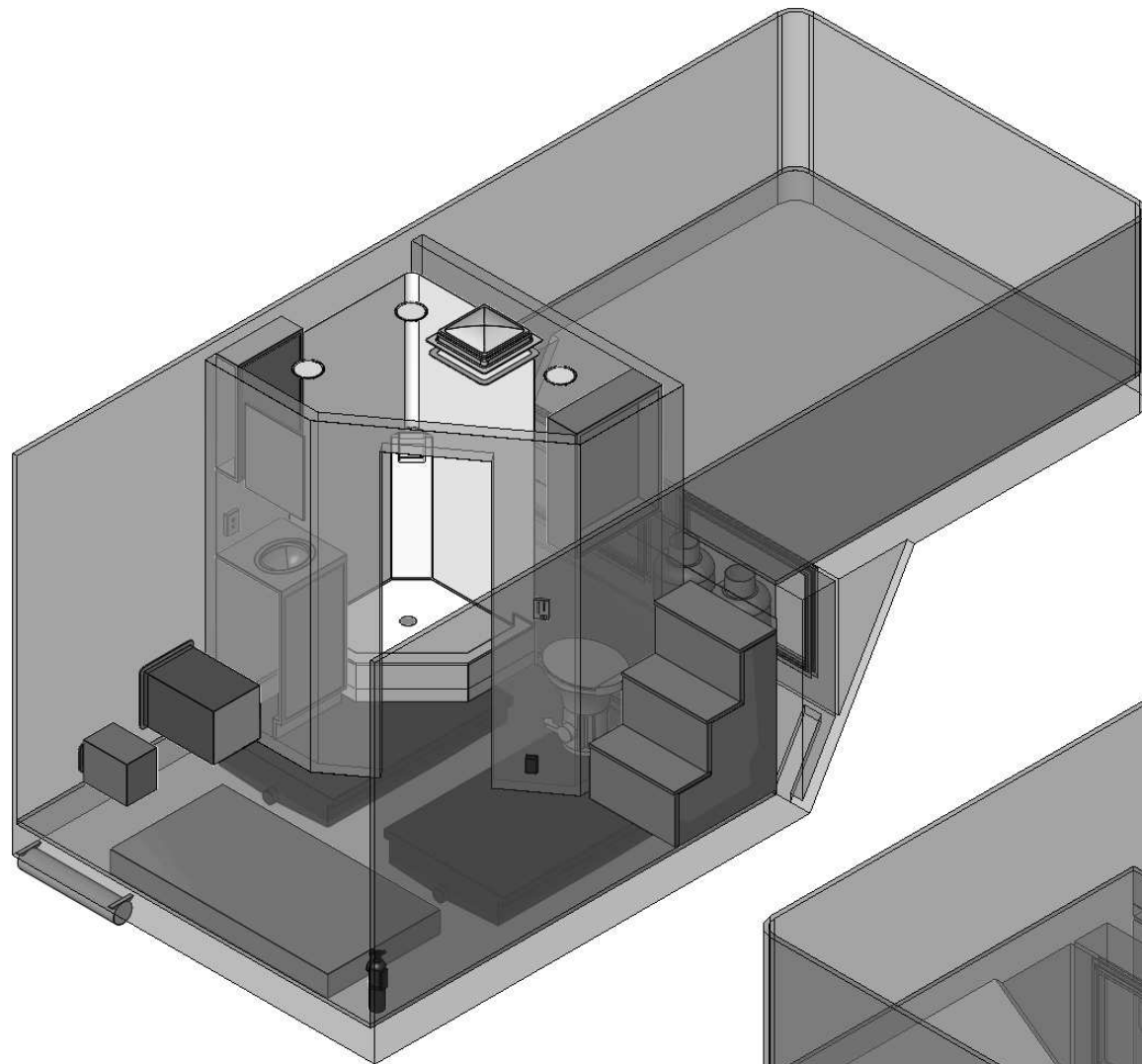

CURB SIDE VIEW

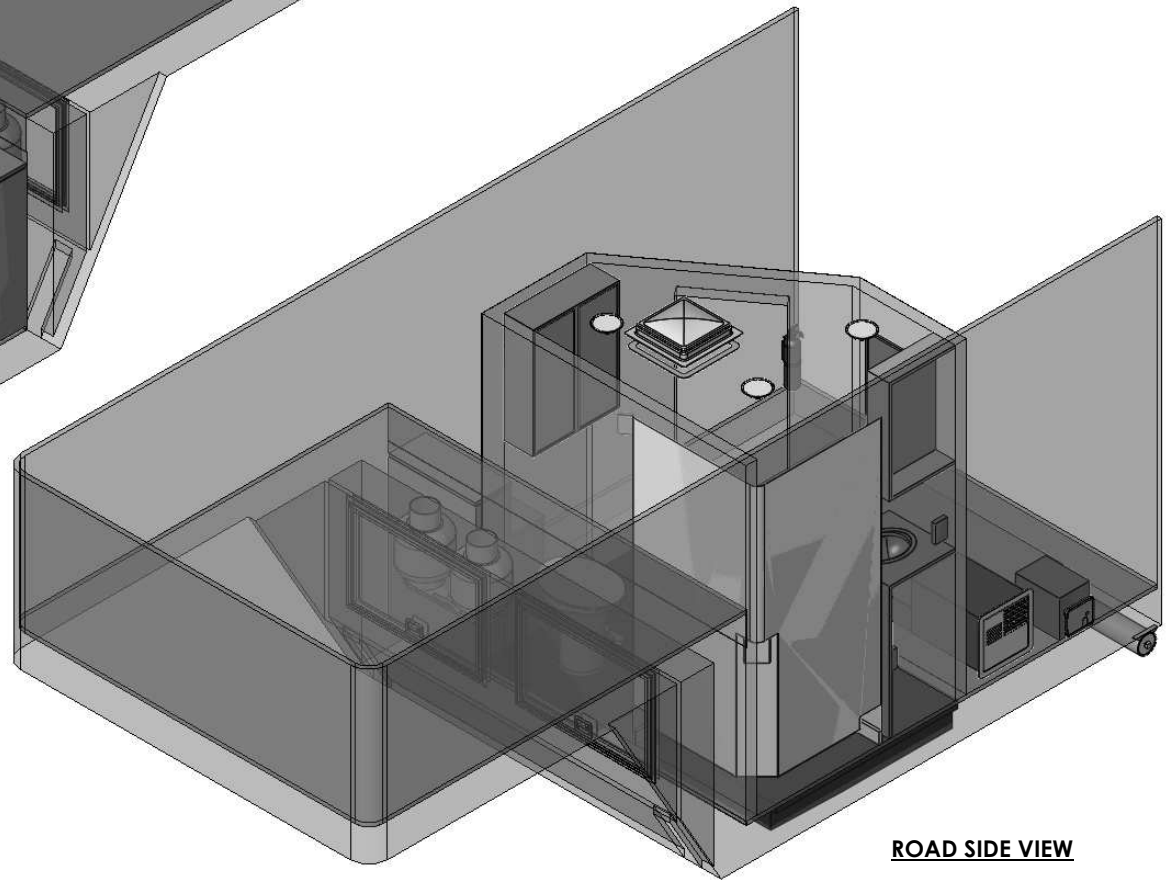

ROAD SIDE VIEW



TITLE: GN3 WALK AROUND BATH			
DRAWN BY: LDS	DATE: 1/20/15	VIN/PART # STD PKG	REV. C
FILE NAME: GN3			
SCALE: 1:18	DATE PRINTED: 10/5/2015	SHEET 4 OF 4	