

ITEM NO.	PART NUMBER	DESCRIPTION	QTY.
49	WATER TANK	W1306 94GAL.	1
48	WATER HEATER	6GAL	1
47	WASTE TANK	H1026 45.5 GAL	2
46	TOILET		1
45	TABLE - SOFA		1
44	STEP ASSY, AL - SLIDE IN-OUT		1
43	SOFA		1
42	SINK, SINGLE BOWL SST	17 x 22 Single Bowl	1
41	SINK, OVAL SST 13.25 x 10.5 x 5		1
40	SHOWER ANGLE	SHOWER CORNER GTS-3434	1
39	ROOF VENT	MANUAL	2
38	REGISTER, HEAT	8 x 4	1
37	REGISTER, HEAT	10 x 2	3
36	PORCH LIGHT		1
35	OUTLET	COAX - EXTERIOR INLET	1
34	OUTLET	ANTENNA AMPLIFIER (12V & COAX)	1
33	OUTLET	120V 15A EXTERIOR	1
32	OUTLET	120V 15A INTERIOR	7
31	MIRROR - FRAMED		1
30	MICROWAVE, IN CABINET	CONTOURE 1.0 900w	1
29	MATTRESS		1
28	LP TANKS		1

ITEM NO.	PART NUMBER	DESCRIPTION	QTY.
27	LIGHT, SCNCE		1
26	LADDER GN		1
25	HOOD, RANGE		1
24	GRAB HANDLE	GRAB HANDLE - LIGHTED	1
23	FURNACE	35K BTU (SH-35)	1
22	FRIG-	6.0 cu ft 3-WAY DOMETIC	1
21	FIRE EXTINGUISHER		1
20	FILL, WATER	City+Gravity	1
19	COOK TOP, 2 BURNER	DROP-IN	1
18	CONVERTER - 12VDC	55 AMP	1
16	CAB TV OH		1
15	CAB TOILET OVERHEAD		1
14	CAB RANGE-MICRO OH		1
13	CAB MEDICINE		1
12	CAB LR WARDROBE		1
11	CAB LAV BASE		1
10	CAB KITCHEN SINK BASE		1
9	CAB FRIG		1
8	CAB BEDROOM SHIRT CLOSET		2
7	CAB BEDROOM OH		1
6	CAB BEDROOM HEADBOARD		1
5	CAB BEDROOM CORNER		1
4	CAB BEDROOM CORNER		1
3	BATTERY	BATTERY - 540 COLD CRANK	2
2	ANTENNA OMNIDIRECTIONAL		1
1	18" LED RECESSED 12V	18" NO TRIM RING	6

BOM TABLE
ALL LOCATIONS ARE NOMINAL UNLESS CRITICAL DIMENSIONS ARE SPECIFICALLY NOTED



TITLE: 12' LIVING QUARTERS			
DRAWN BY: NjM	DATE: 9/12/12	VIN/PART #	REV. B
FILE NAME: 12'LQ	SCALE: 1:16	DATE PRINTED: 3/13/2014	SHEET 1 OF 5

REV.	DESCRIPTION	DATE	APPROVED
B	CHANGED TO SLIDE STEP	3/13/2014	LDS
A	CHANGED COOKTOP, LIGHTS TO NO TRIM RING, REMOVED (1) OUTLET ON RISER WALL; CHANGED TO FINISHED DIMENSIONS	7/19/2013	JRS

PROPRIETARY AND CONFIDENTIAL: THE INFORMATION CONTAINED IN THIS DRAWING IS THE SOLE PROPERTY OF THE ALUMINUM TRAILER COMPANY. ANY REPRODUCTION IN PART OR AS A WHOLE WITHOUT THE WRITTEN PERMISSION OF THE ALUMINUM TRAILER COMPANY IS PROHIBITED.

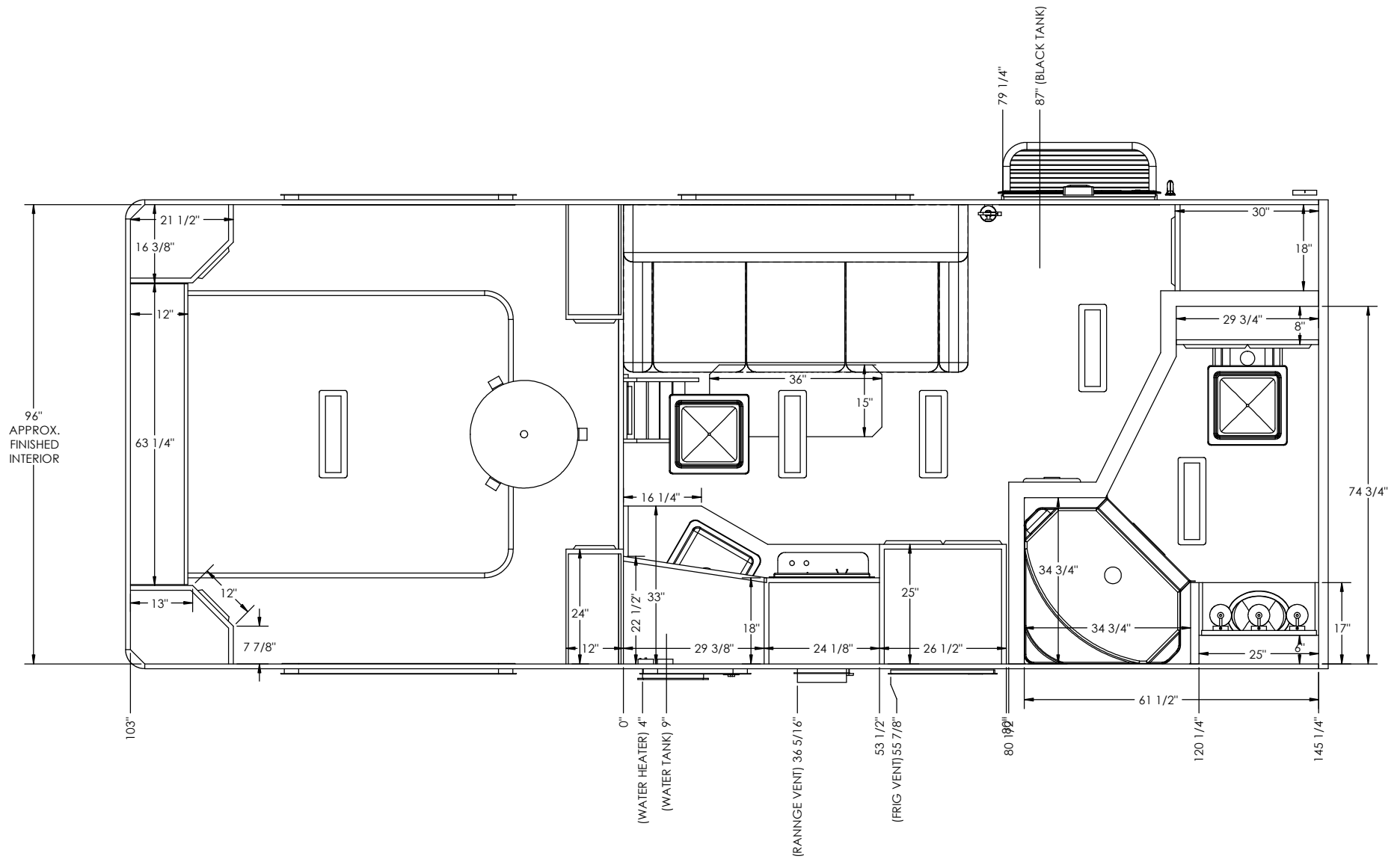

TITLE: 12' LIVING QUARTERS			
DRAWN BY: NjM	DATE: 9/12/12	VIN/PART # STD PKG	REV. B
FILE NAME: 12'LQ			
SCALE: 1:15	DATE PRINTED: 3/13/2014	SHEET 2 OF 5	

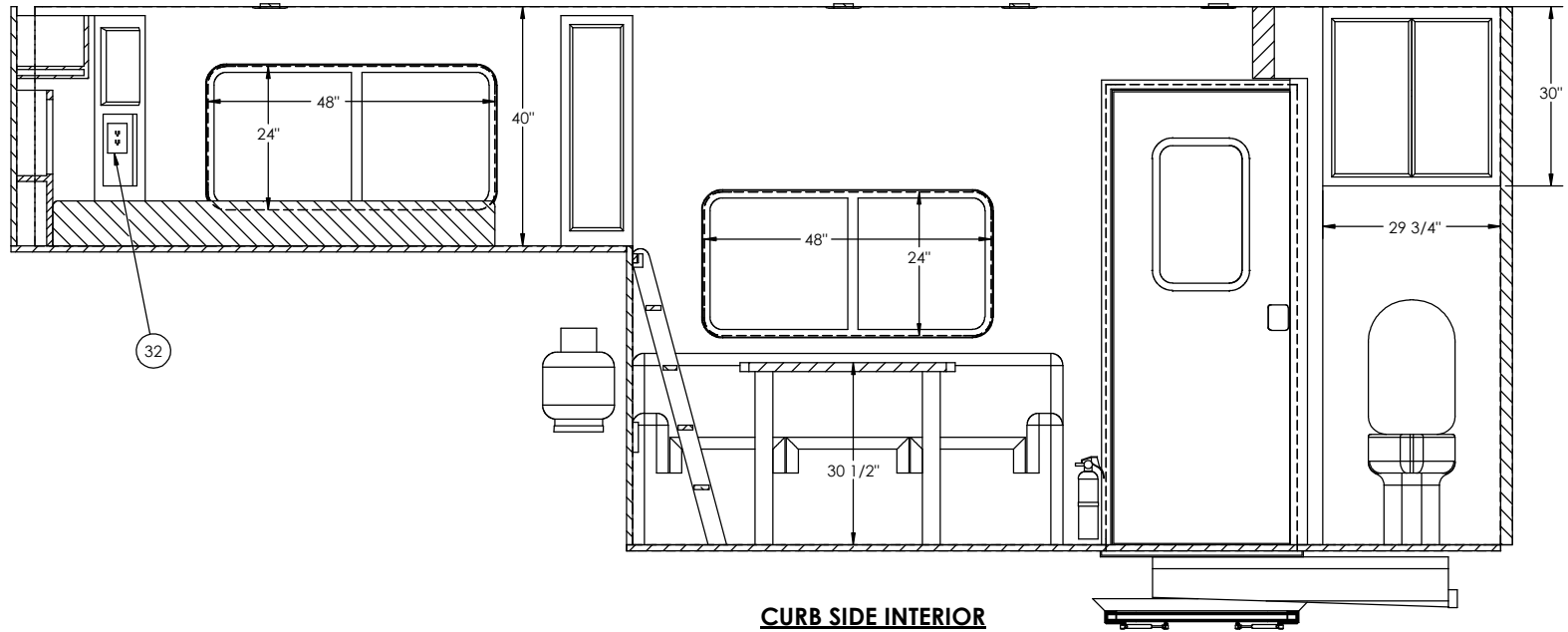

CURB SIDE INTERIOR
SECTION A-A

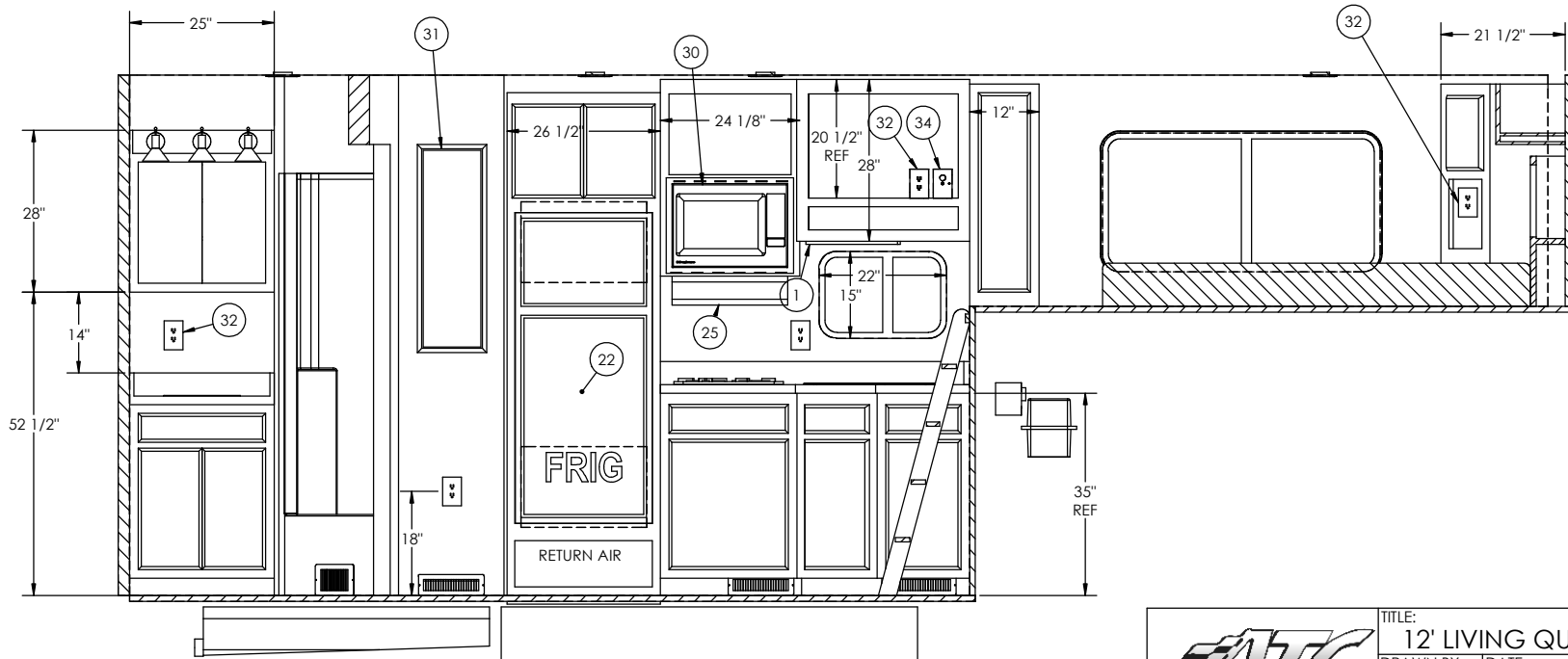

ROADSIDE INTERIOR
SECTION B-B



TITLE: 12' LIVING QUARTERS			
DRAWN BY: NjM	DATE: 9/12/12	VIN/PART # STD PKG	REV. B
FILE NAME: 12'LQ			
SCALE: 1:16	DATE PRINTED: 3/13/2014	SHEET 3 OF 5	

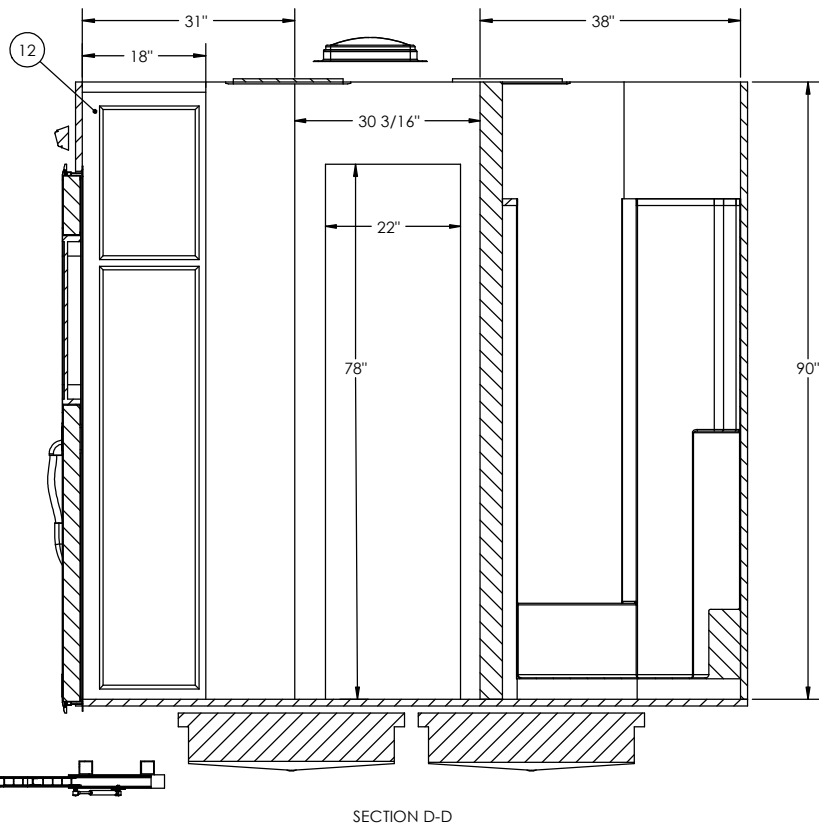
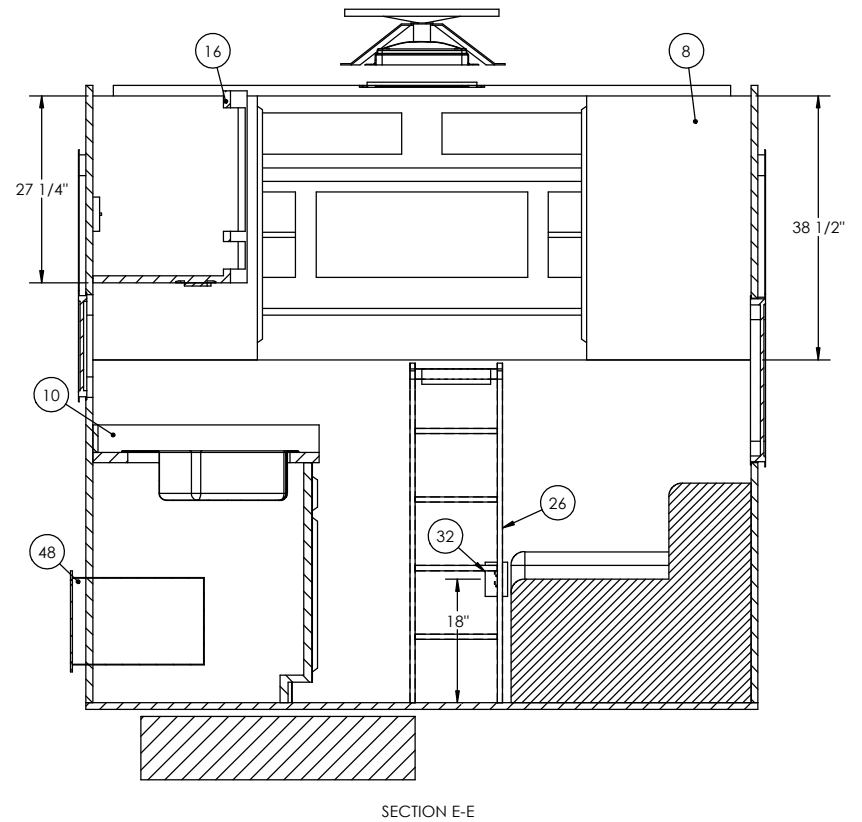
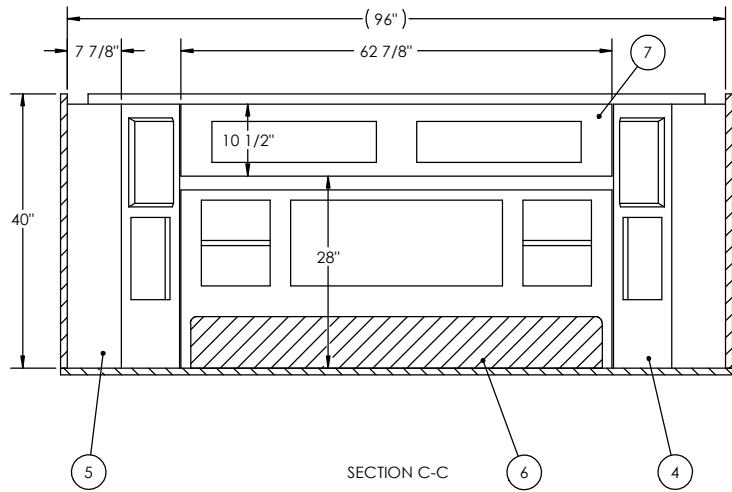

TITLE: 12' LIVING QUARTERS			
DRAWN BY: NjM	DATE: 9/12/12	VIN/PART # STD PKG	REV. B
FILE NAME: 12'LQ			
SCALE: 1:14	DATE PRINTED: 3/13/2014	SHEET 4 OF 5	

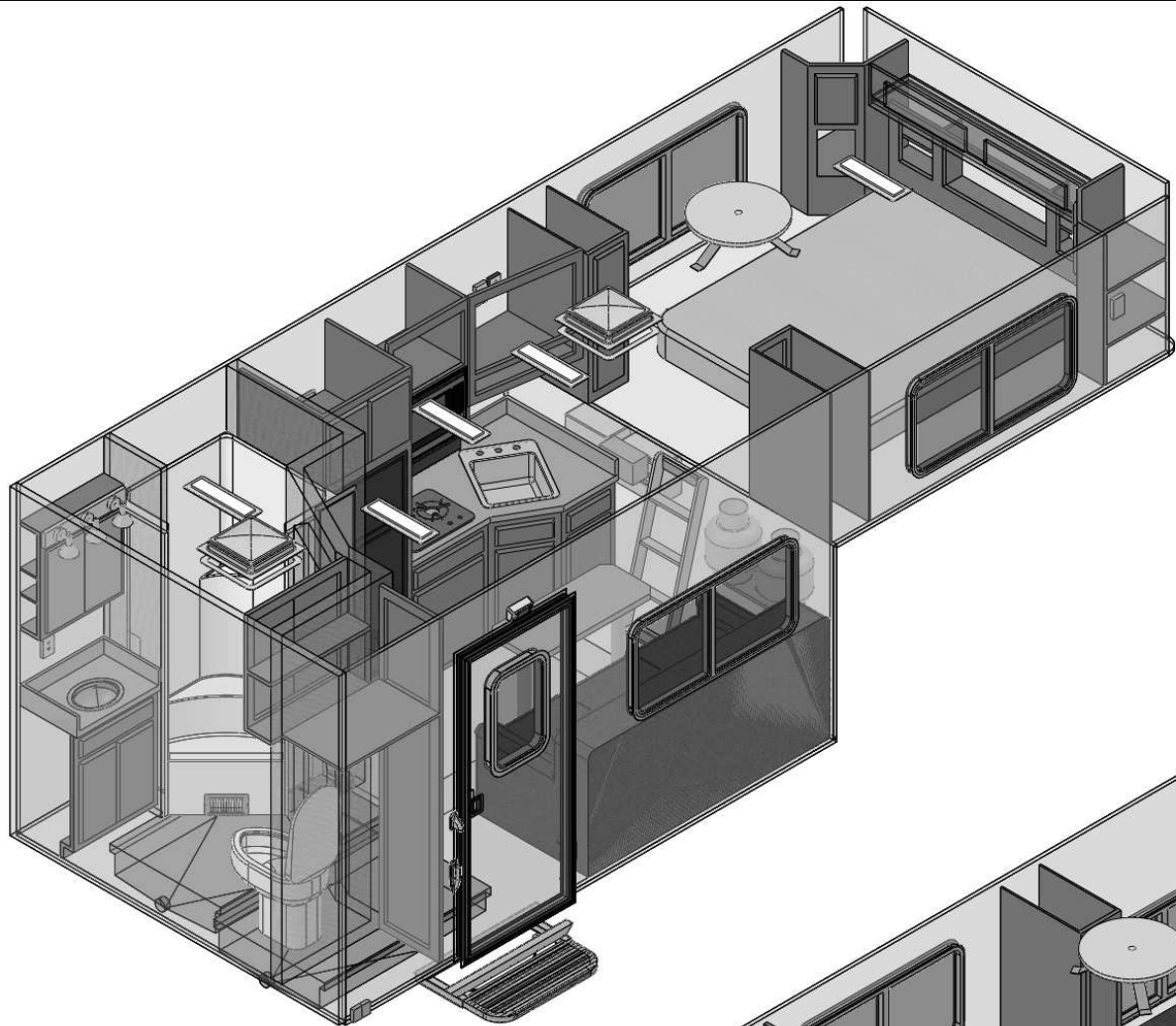

CURB SIDE VIEW

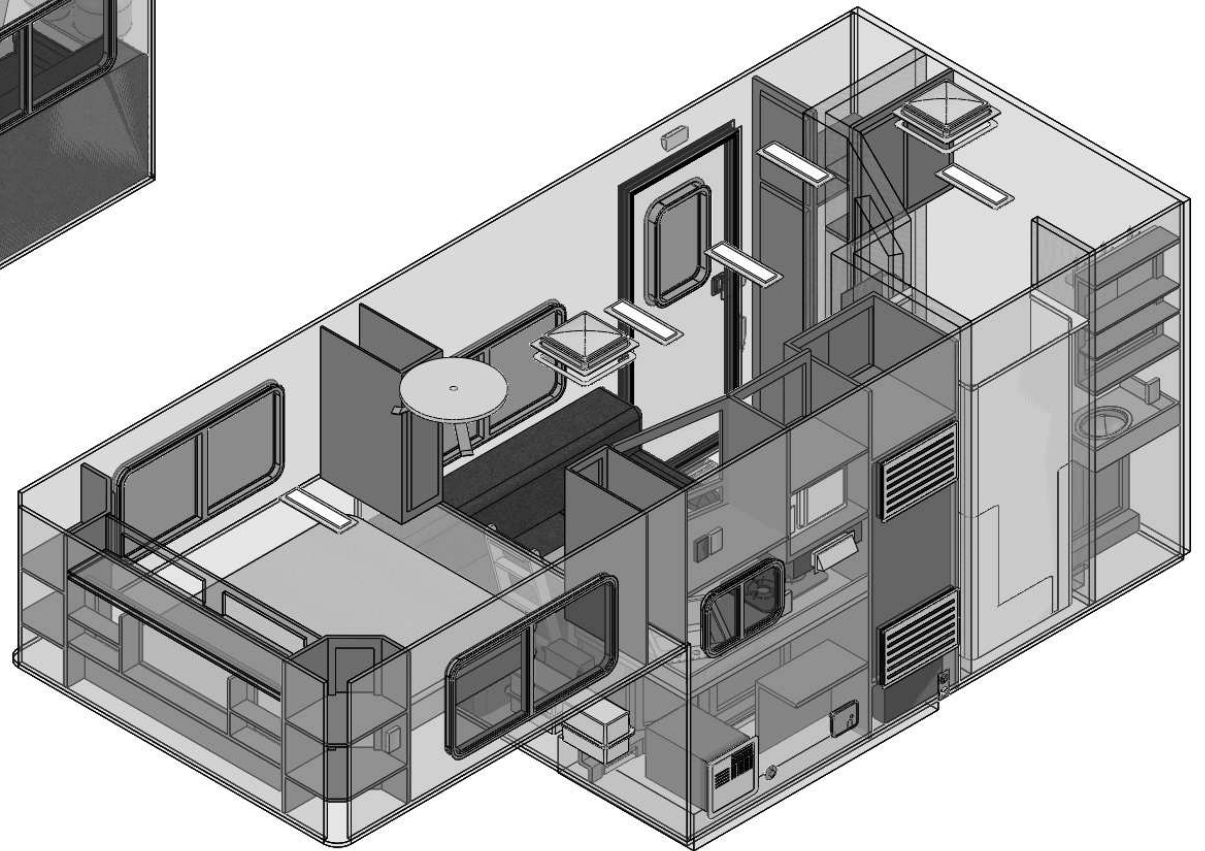

ROADSIDE VIEW

 WORLD CLASS TRAILERS		TITLE: 12' LIVING QUARTERS		REV.:
		DRAWN BY: NjM	DATE: 9/12/12	VIN/PART # STD PKG
FILE NAME: 12'LQ				
SCALE: 1:20	DATE PRINTED: 3/13/2014		SHEET 5 OF 5	