

15		WATER TANK	W0019 19.5GAL.	1
14		WASTE TANK	H469 8.5GAL	1
13		TOILET PLATFORM S-PKG		1
12	37104	TOILET	DOMETIC 111	1
11		SWITCH-BATTERY CUT-OFF		1
10	13849	SEWER HOSE COMP.		1
9	14618	ROOF VENT	12V	1
8	12492-w/12494-b	MONITOR PANEL - TANKS	3 TANK	1
7		LP TRAY		1
6		LP TANK	20#	2
5	13518	FIRE EXTINGUISHER		1
4	20064	FILL, WATER	Gray	1
3		CABINET S1		1
2	20571	BATTERY BOX PLASTIC	BATTERY - 540 COLD CRANK	1
1	33653	18" LED RECESSED 12V	18" RECESSED	1
ITEM NO.	PART NO	FILE NAME	DESCRIPTION	QTY.

BOM TABLE

ALL LOCATIONS ARE NOMINAL UNLESS CRITICAL DIMENSIONS ARE SPECIFICALLY NOTED

PROPRIETARY AND CONFIDENTIAL:
 THE INFORMATION CONTAINED IN THIS DRAWING IS THE SOLE PROPERTY OF THE ALUMINUM TRAILER COMPANY. ANY REPRODUCTION IN PART OR AS A WHOLE WITHOUT THE WRITTEN PERMISSION OF THE ALUMINUM TRAILER COMPANY IS PROHIBITED.



TITLE: S1 - FLAT FRONT			
DRAWN BY: JRS	DATE: 04.18.13	VIN/PART #	REV.
FILE NAME: S1-FF			
SCALE:1:20	DATE PRINTED: 4/19/2013	SHEET 1 OF 5	

REV.	DESCRIPTION	DATE	DONE BY
REVISION TABLE			
DWG PATH: X:\Options\S-PKG\			

NOTE: ALL DIMENSIONS ARE NOMINAL UNLESS IDENTIFIED AS CRITICAL.

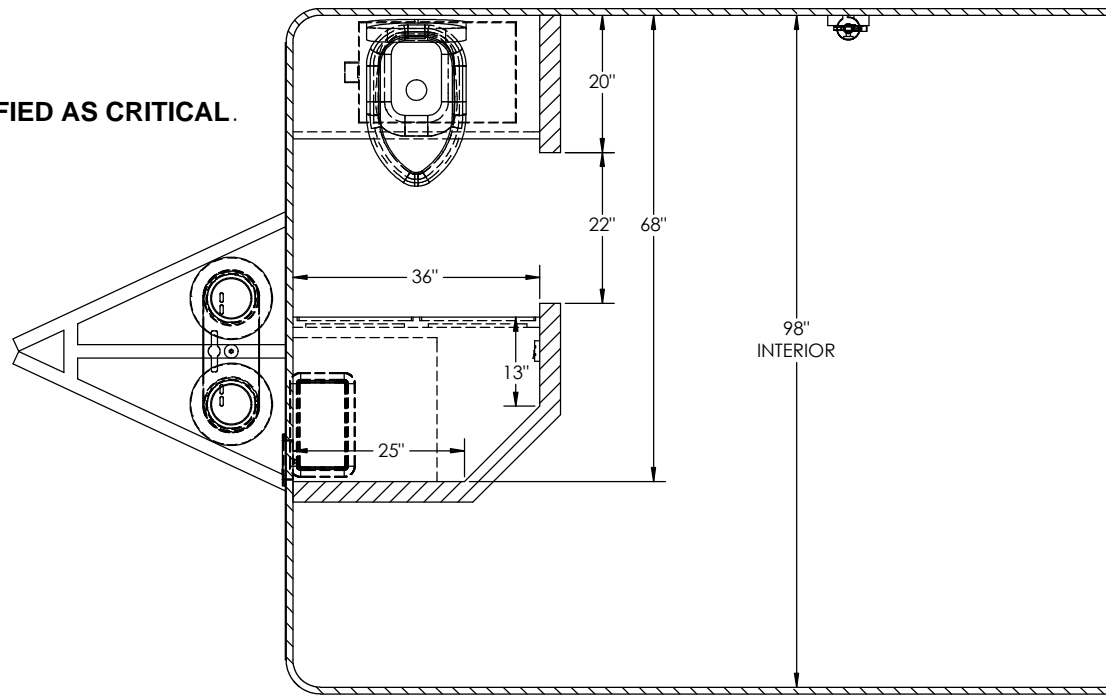

SECTION E-E

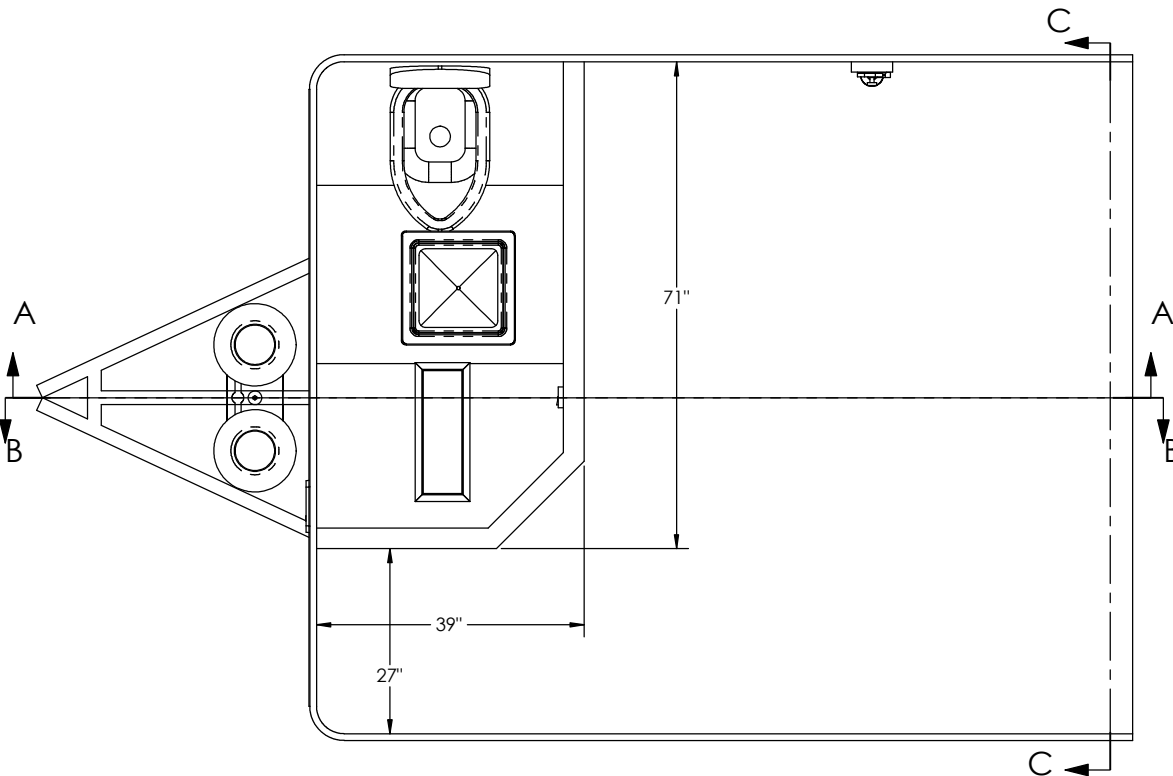

TITLE: S1 - FLAT FRONT			
DRAWN BY: JRS	DATE: 04.18.13	VIN/PART #	REV.
FILE NAME: S1-FF			
SCALE: 1:14	DATE PRINTED: 4/19/2013	SHEET 2 OF 5	

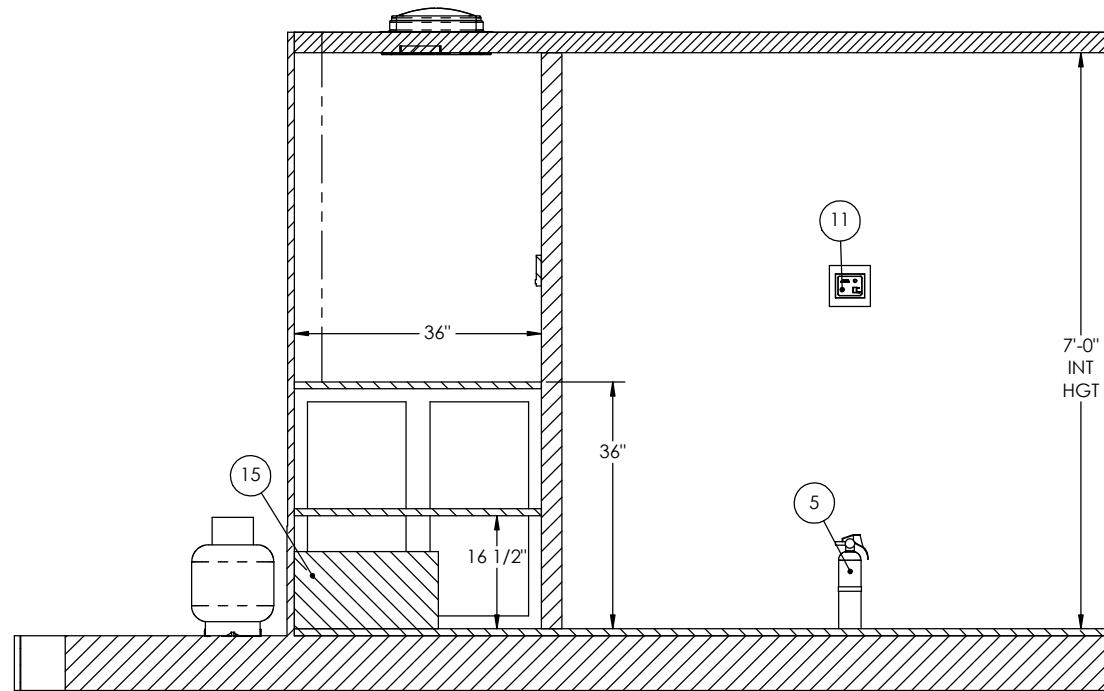

INTERIOR CURB SIDE
SECTION A-A

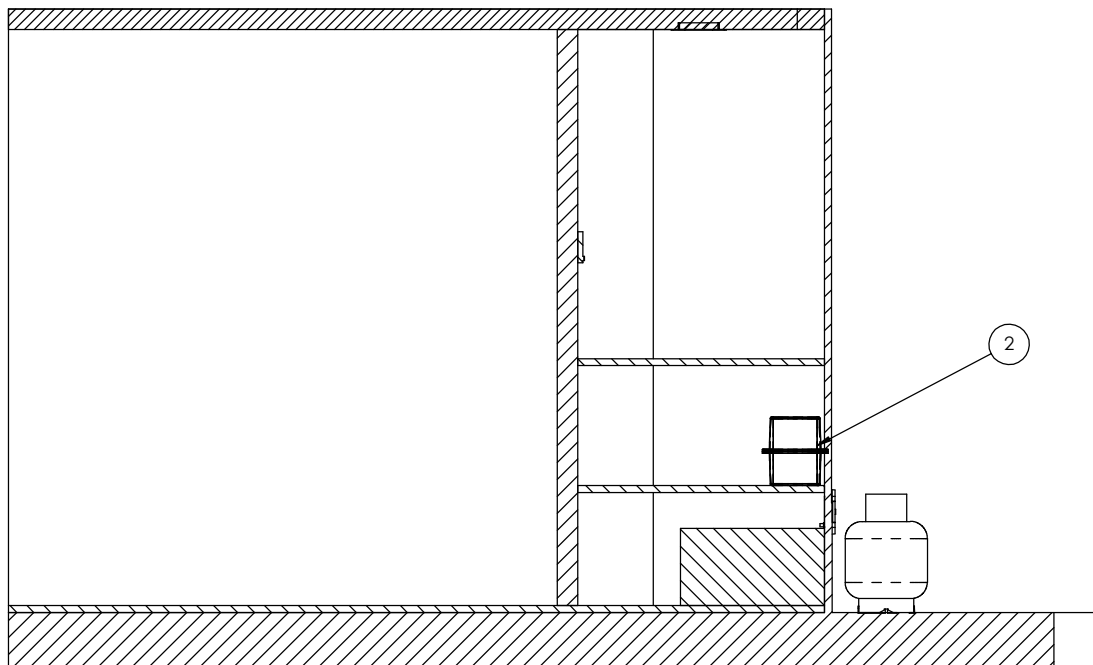

INTERIOR ROAD SIDE
SECTION B-B



TITLE: S1 - FLAT FRONT			
DRAWN BY: JRS	DATE: 04.18.13	VIN/PART #	REV.
FILE NAME: S1-FF			
SCALE: 1:14	DATE PRINTED: 4/19/2013	SHEET 3 OF 5	

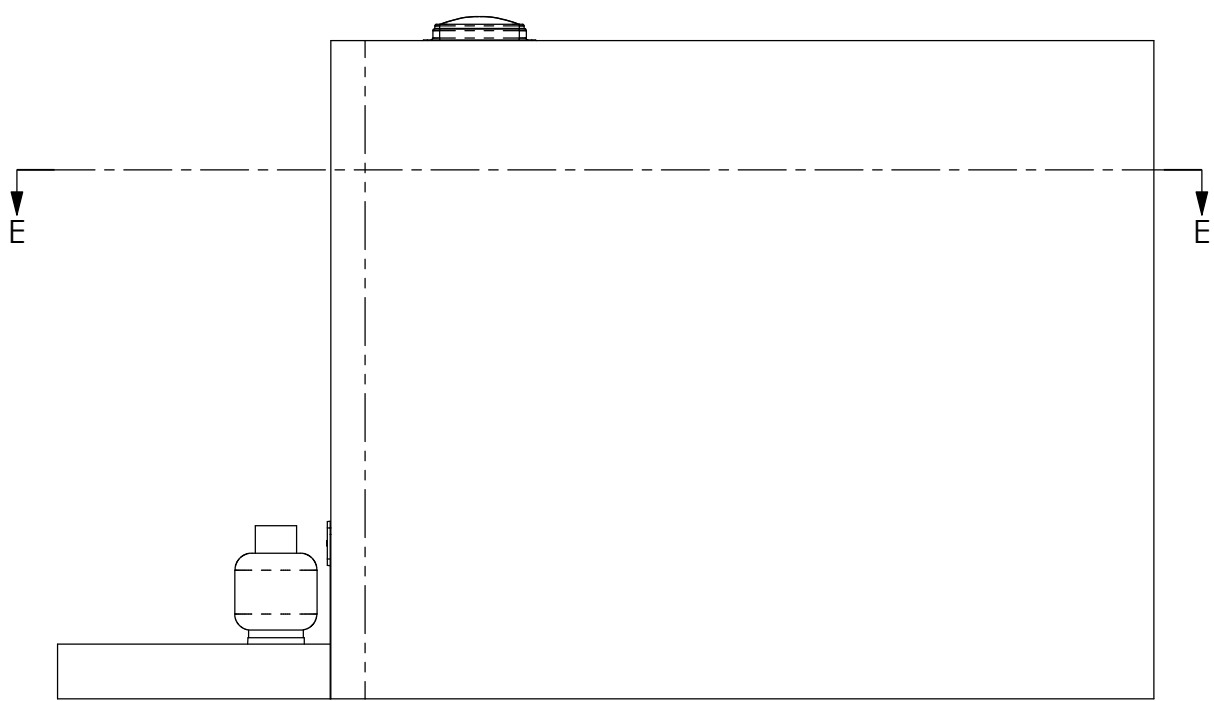

EXTERIOR ROAD SIDE

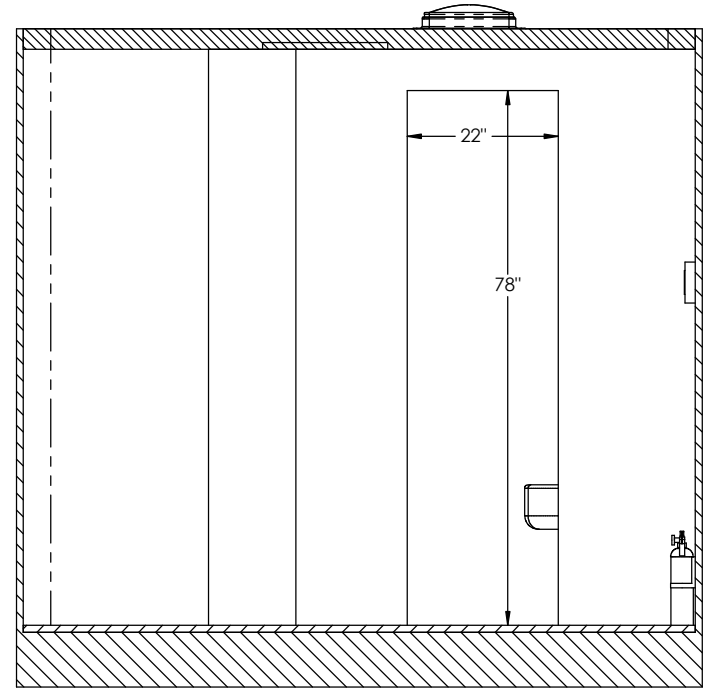

INTERIOR FRONT
SECTION C-C

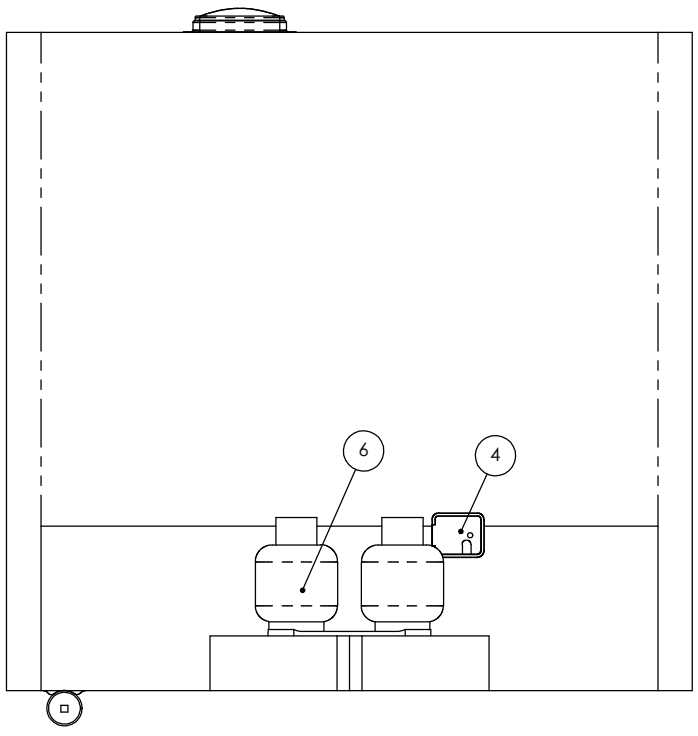

EXTERIOR FRONT

	TITLE: S1 - FLAT FRONT			
	DRAWN BY: JRS	DATE: 04.18.13	VIN/PART #	REV.
	FILE NAME: S1-FF			
	SCALE: 1:14	DATE PRINTED: 4/19/2013	SHEET 4 OF 5	

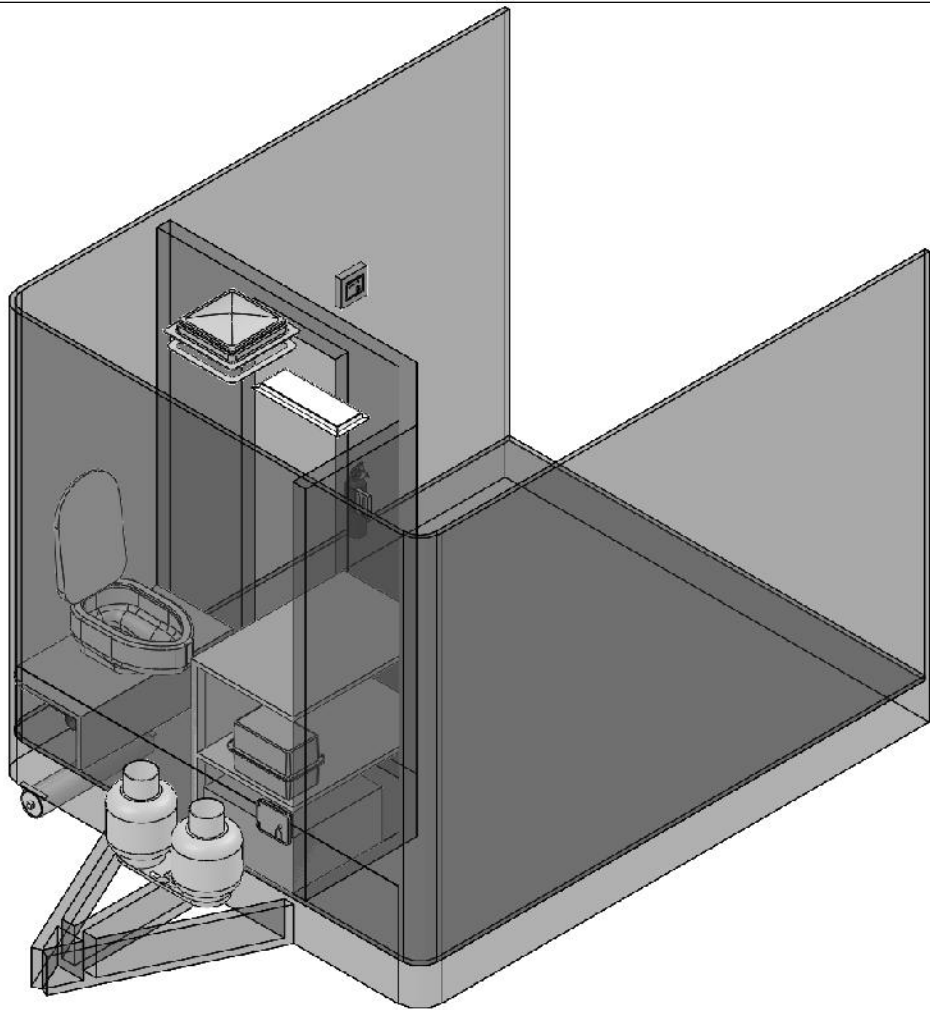

ROAD SIDE VIEW

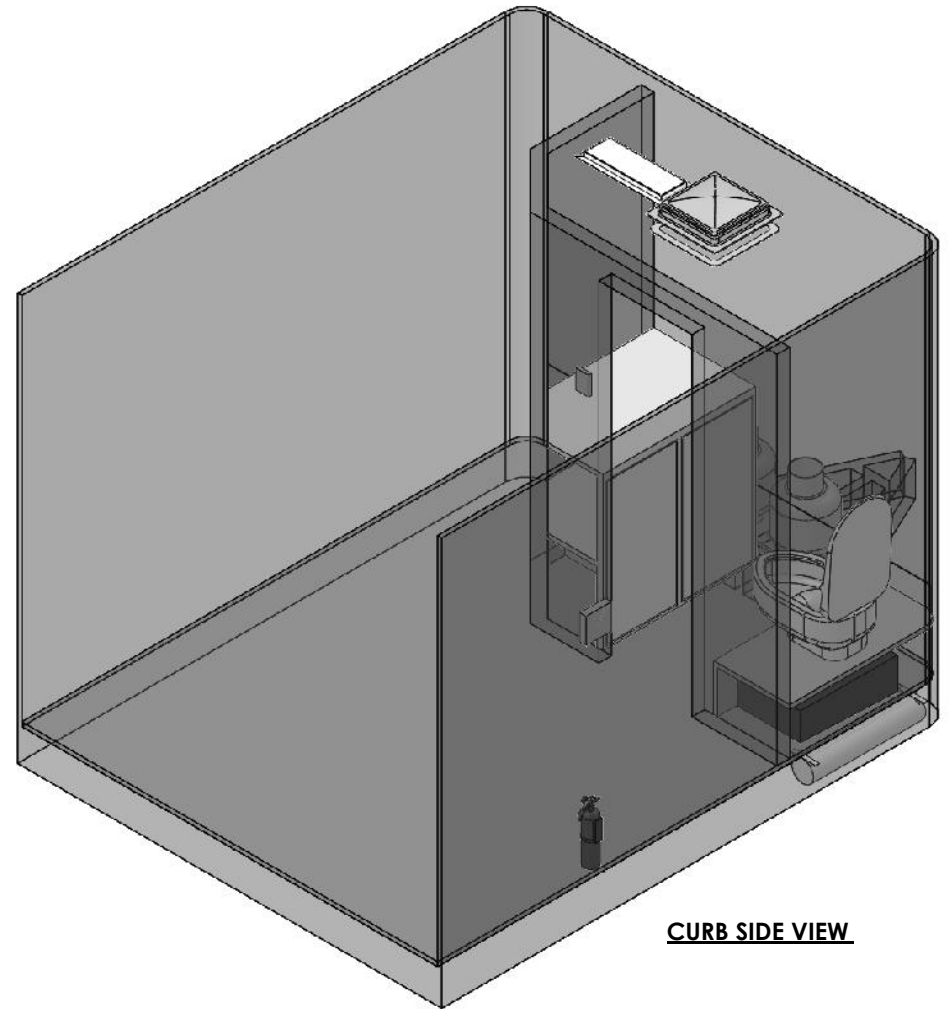

CURB SIDE VIEW

		TITLE: S1 - FLAT FRONT		REV.
		DRAWN BY: JRS	DATE: 04.18.13	VIN/PART #
FILE NAME: S1-FF				
SCALE: 1:16	DATE PRINTED: 4/19/2013		SHEET 5 OF 5	