

BOM TABLE				
ITEM NO	PART NO	FILE NAME	DESCRIPTION	QTY
1		CAB. STORAGE FF S3-PKG		1
2		CABINET, VANITY FF S3-PKG		1
3		COVER, WATER FILL		1
4	20064	FILL, WATER	City+Gravity	1
5	12265	LIGHT, DOME	SURFACE MOUNT	2
6		MIRROR		1
7	26281-w/12498-b	MONITOR PANEL, TANKS	2 TANK	1
8	11978	OUTLET, ELECTRICAL	120V 15A INTERIOR	1
9	14618	ROOF VENT	12V	1
10		S2-FF-BATH WALL-		1
11	13849	SEWER HOSE COMP.		1
12	13798	SINK, OVAL SST 13.25 x 10.5 x 5		1
13	37019	TOILET		1
14		WASTE TANK, RS TONGUE	42GAL - 21053	1
15	14119	WATER TANK	W0926 42 GAL	1

ALL LOCATIONS ARE NOMINAL UNLESS CRITICAL DIMENSIONS ARE SPECIFICALLY NOTED

PROPRIETARY AND CONFIDENTIAL:
 THE INFORMATION CONTAINED IN THIS DRAWING IS THE SOLE PROPERTY OF THE ALUMINUM TRAILER COMPANY. ANY REPRODUCTION IN PART OR AS A WHOLE WITHOUT THE WRITTEN PERMISSION OF THE ALUMINUM TRAILER COMPANY IS PROHIBITED.



TITLE:
S2 - FLAT FRONT

DRAWN BY: LDS	DATE: 1/20/14	VIN/PART # STD PKG A	REV. A
FILE NAME: S2-Flat Front		SCALE: 1:20	DATE PRINTED: 7/21/2015
			SHEET 1 OF 5

A	MOVED PART WALL BACK-MODIFIED CABS	3/19/2015	LDS
REV.	DESCRIPTION	DATE	DONE BY
REVISION TABLE			
DWG PATH: X:\Options\S-PKG\			

NOTE: ALL DIMENSIONS ARE NOMINAL UNLESS IDENTIFIED AS CRITICAL.

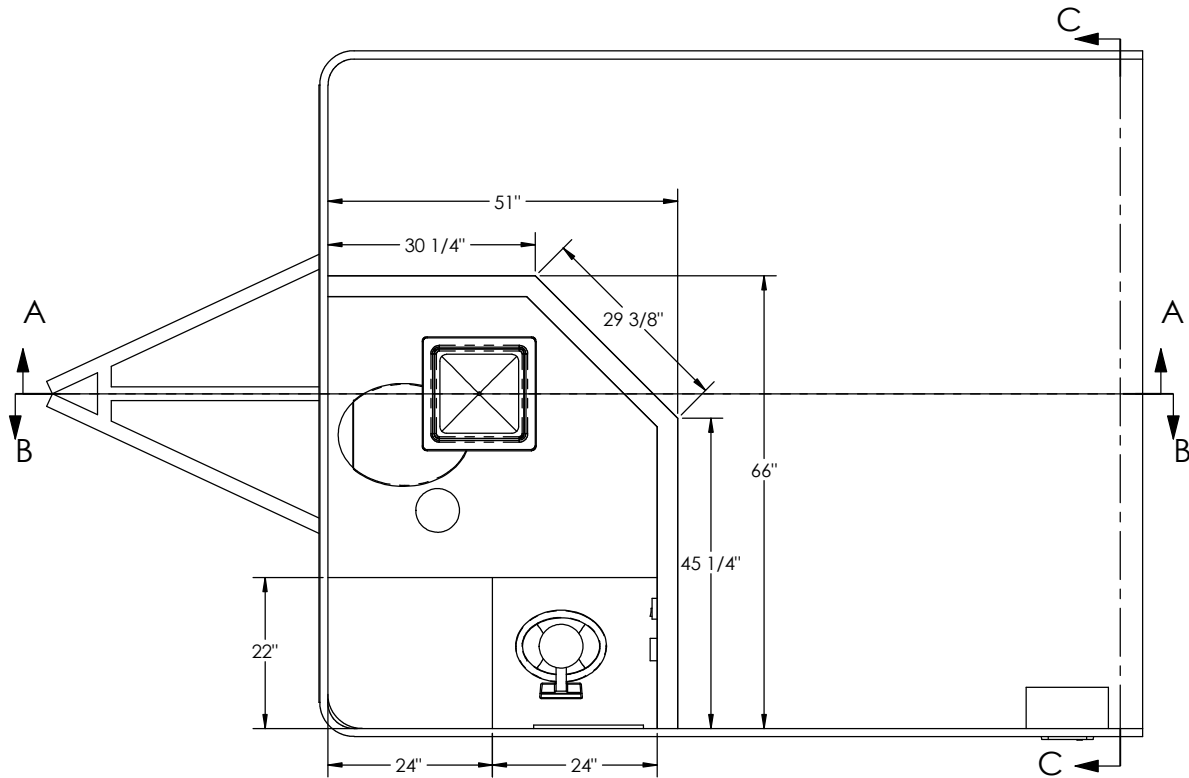
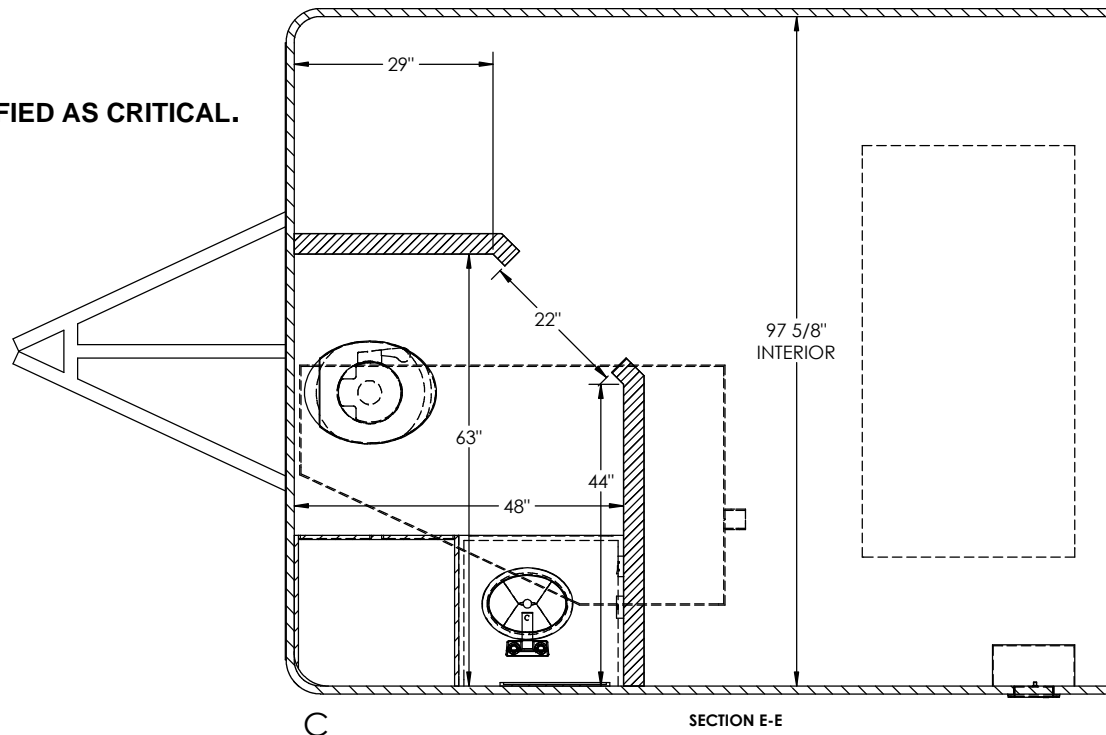

TITLE: S2 - FLAT FRONT			
DRAWN BY: LDS	DATE: 1/20/14	VIN/PART # STD PKG	REV. A
FILE NAME: S2-Flat Front			
SCALE: 1:14	DATE PRINTED: 7/21/2015	SHEET 2 OF 5	

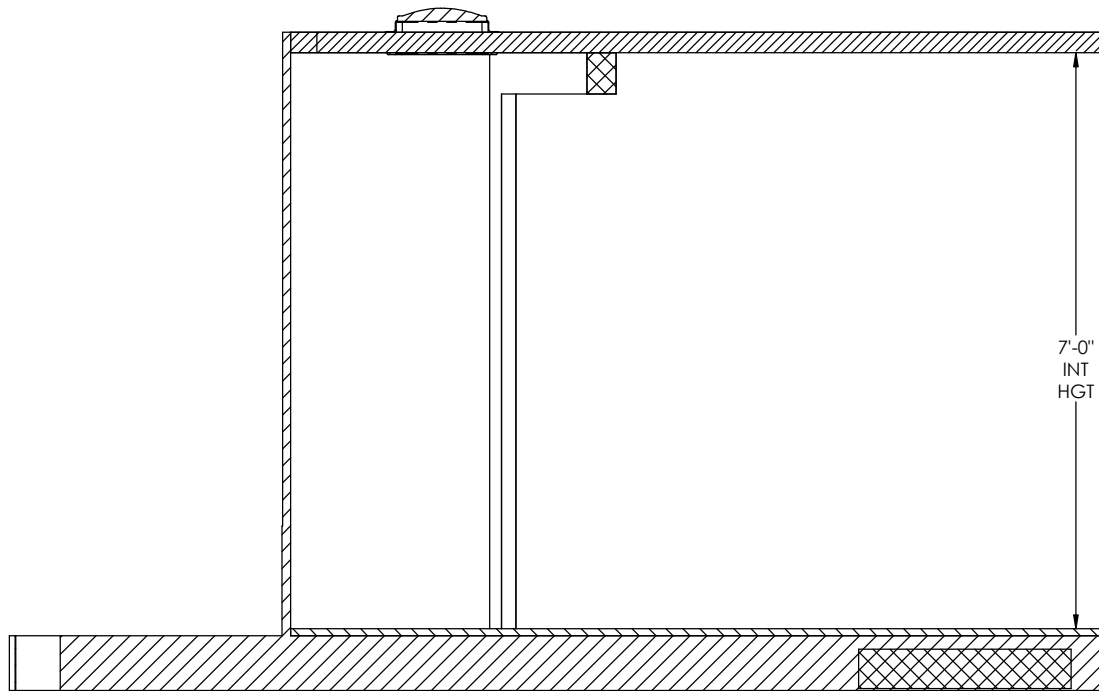

INTERIOR CURB SIDE
SECTION A-A

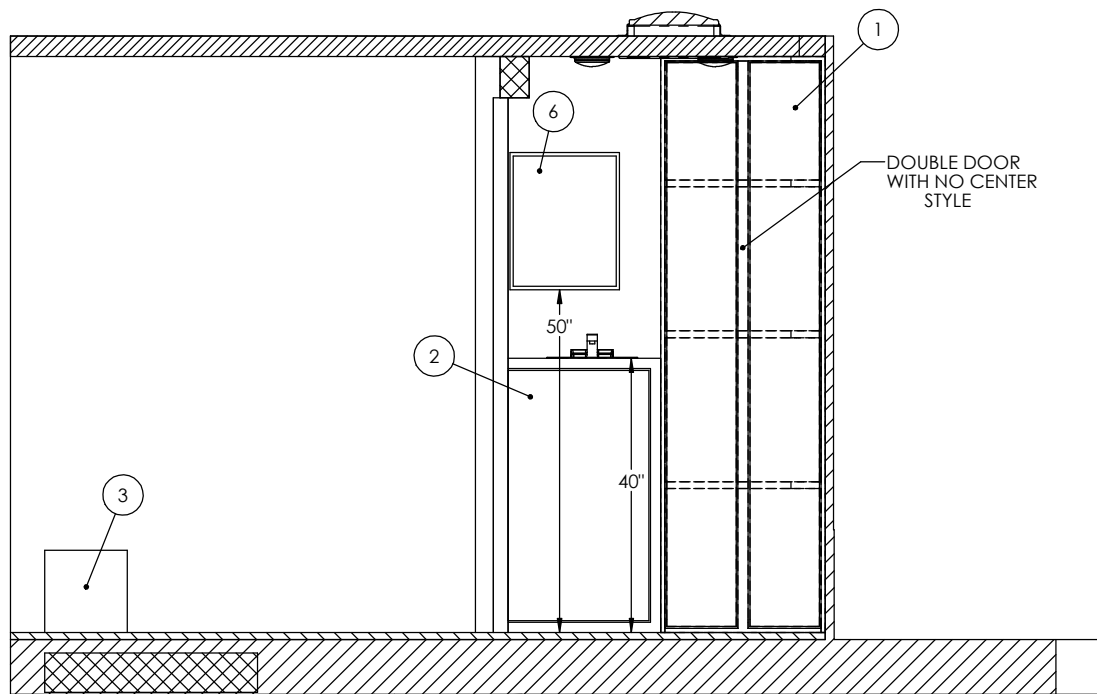

INTERIOR ROAD SIDE
SECTION B-B



TITLE: S2 - FLAT FRONT			
DRAWN BY: LDS	DATE: 1/20/14	VIN/PART #	REV. A
FILE NAME: S2-Flat Front		STD PKG	
SCALE: 1:14	DATE PRINTED: 7/21/2015	SHEET 3 OF 5	

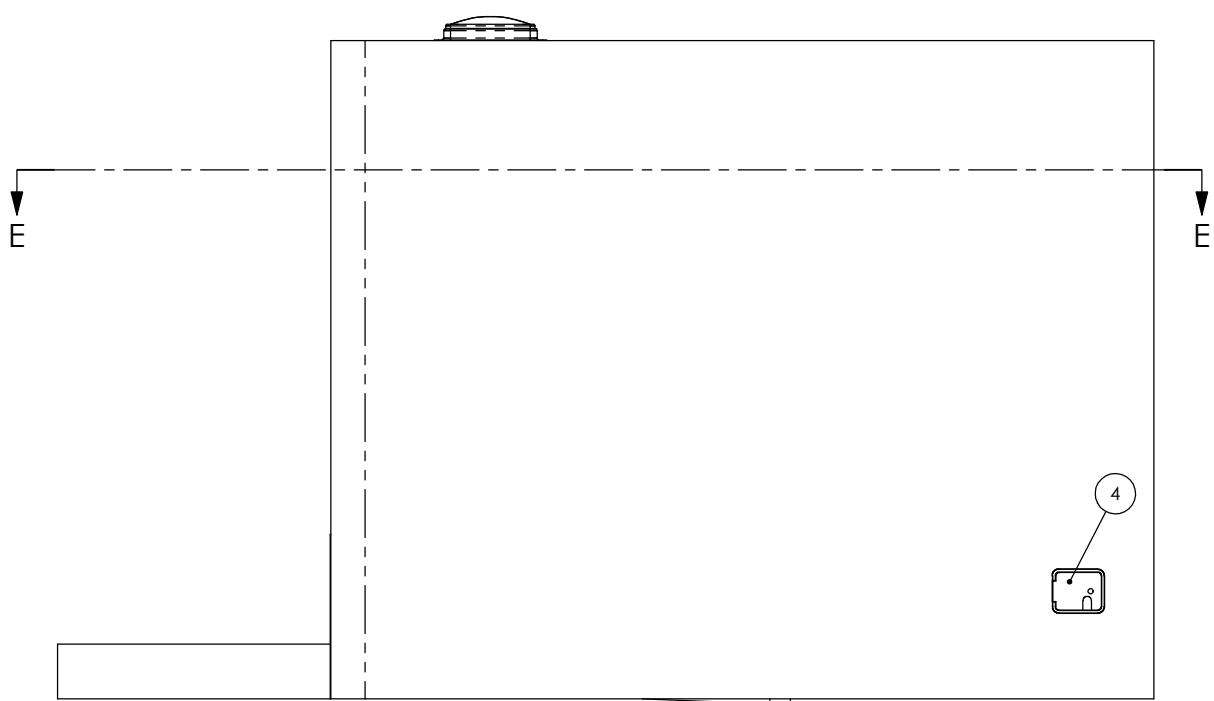

EXTERIOR ROAD SIDE

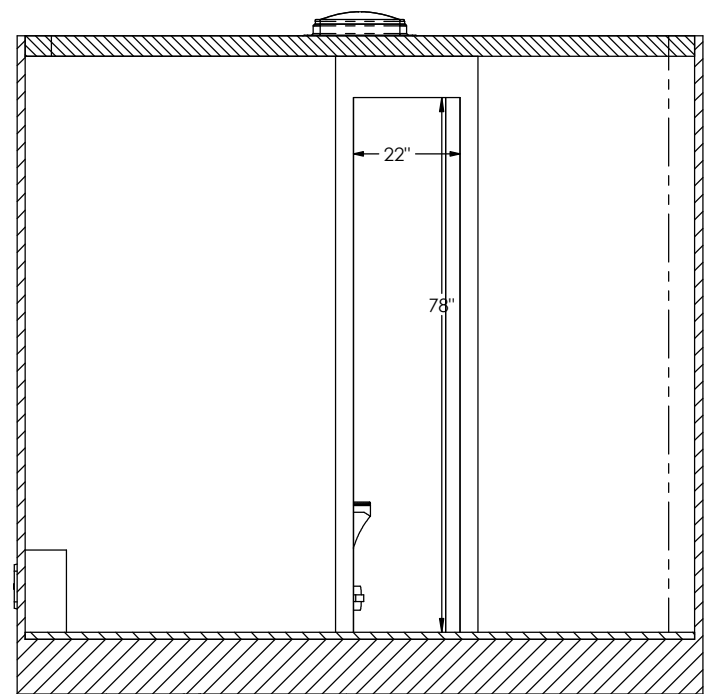

INTERIOR FRONT
SECTION C-C



TITLE: S2 - FLAT FRONT			
DRAWN BY: LDS	DATE: 1/20/14	VIN/PART #	REV. A
FILE NAME: S2-Flat Front		STD PKG	
SCALE: 1:14	DATE PRINTED: 7/21/2015	SHEET 4 OF 5	

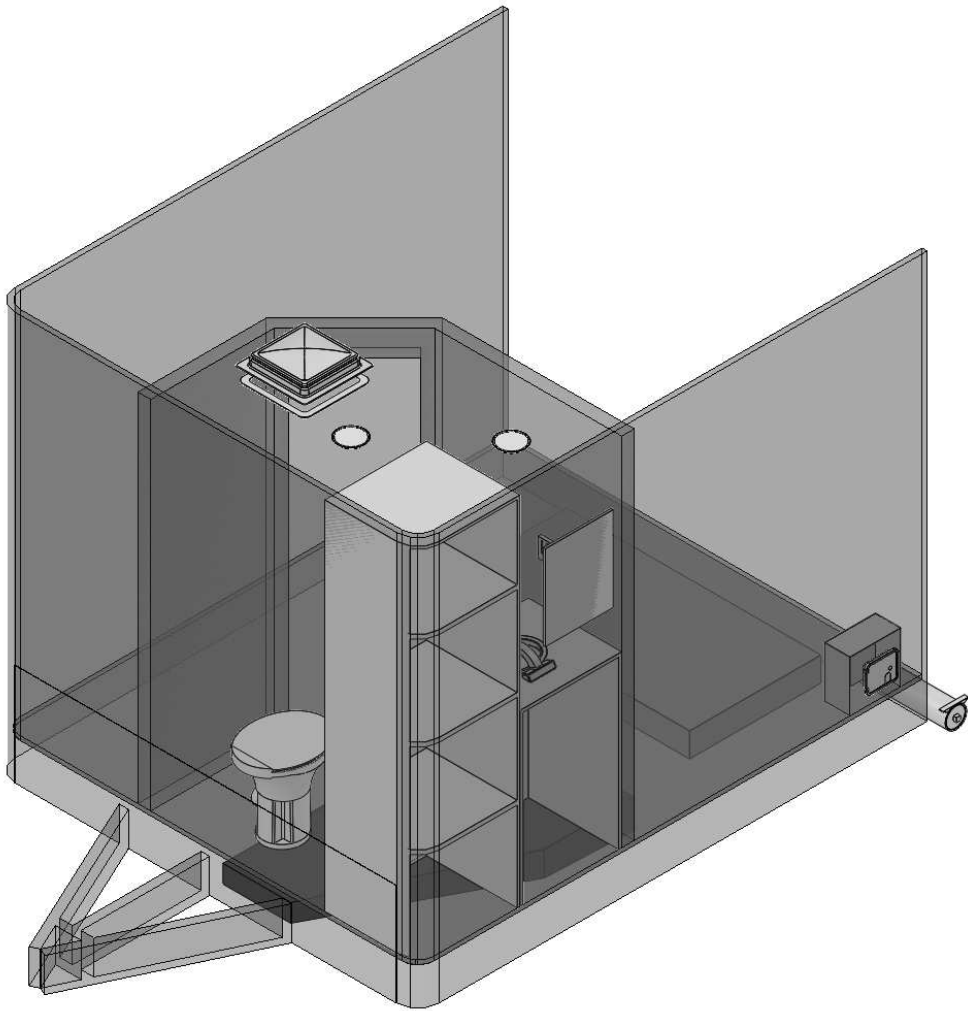

ROAD SIDE VIEW

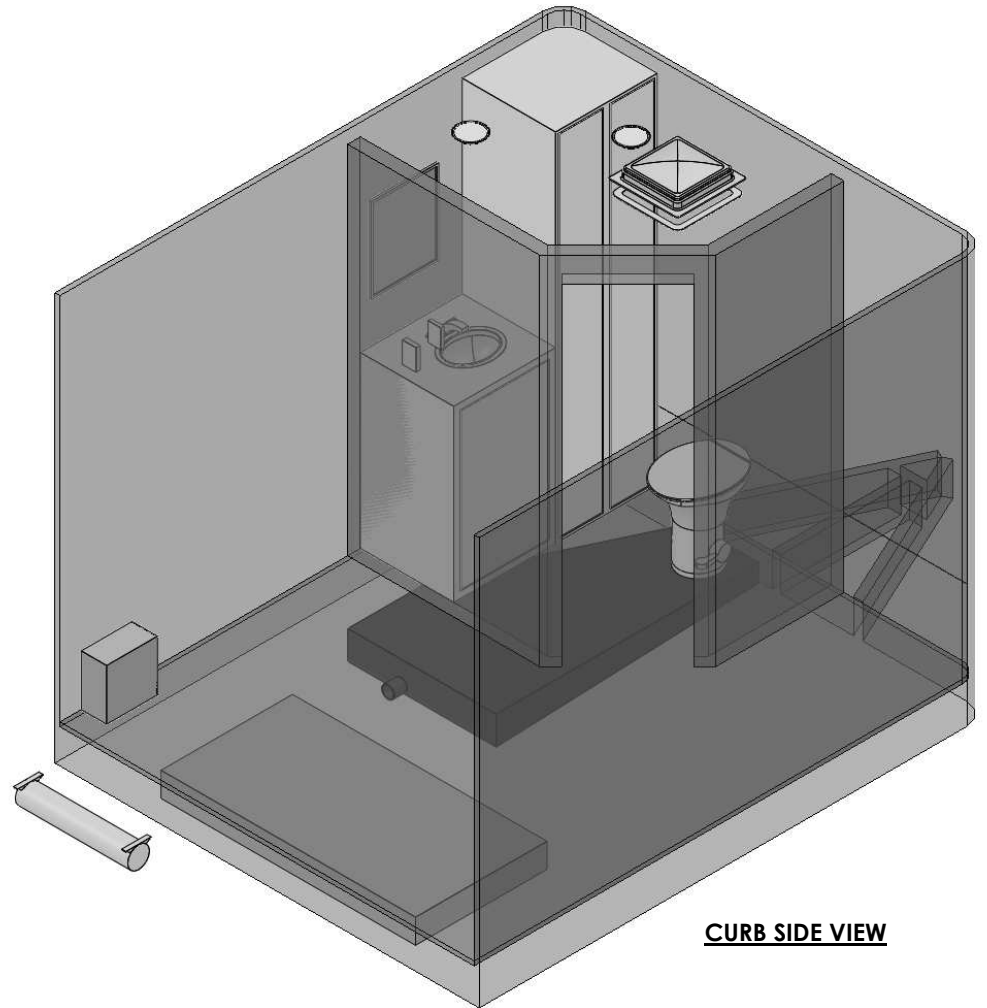

CURB SIDE VIEW

	TITLE: S2 - FLAT FRONT			REV.
	DRAWN BY: LDS	DATE: 1/20/14	VIN/PART # STD PKG	A
FILE NAME: S2-Flat Front				
SCALE: 1:16	DATE PRINTED: 7/21/2015	SHEET 5 OF 5		