

BOM TABLE				
ITEM NO	PART NO	FILE NAME	DESCRIPTION	QTY
1		CAB BASE S3		1
2		CAB LINEN S3		1
3		CAB OVERHEAD S3-		1
4		CAB STORAGE S-PKG		1
5		DOOR		1
6	20064	FILL, WATER	City+Gravity	1
7	13518	FIRE EXTINGUISHER		1
8	12265	LIGHT, DOME	SURFACE MOUNT	3
9	14084	LP DETECTOR		1
10	14094	LP TANK	20#	1
11		MIRROR		1
12	12492-w/12494-b	MONITOR PANEL, TANKS	3 TANK	1
13	11978	OUTLET, ELECTRICAL	120V 15A INTERIOR	1
14		PARTITION WALL S-PKG		1
15	14618	ROOF VENT	12V	1
16	13849	SEWER HOSE COMP.		1
17	13779	SHOWER	S-36 X 28 SHOWER	1
18	13798	SINK, OVAL SST 13.25 x 10.5 x 5		1
19	37019	TOILET		1
20		WASTE TANK, CS TONGUE	42GAL - 21054	1
21		WASTE TANK, RS TONGUE	42GAL - 21053	1
22	10545	WATER HEATER, SUBURBAN	6GAL	1
23	14119	WATER TANK	W0926 42 GAL	1

ALL LOCATIONS ARE NOMINAL UNLESS CRITICAL DIMENSIONS ARE SPECIFICALLY NOTED

PROPRIETARY AND CONFIDENTIAL:
THE INFORMATION CONTAINED IN THIS DRAWING IS THE SOLE PROPERTY OF THE ALUMINUM TRAILER COMPANY. ANY REPRODUCTION IN PART OR AS A WHOLE WITHOUT THE WRITTEN PERMISSION OF THE ALUMINUM TRAILER COMPANY IS PROHIBITED.



TITLE: S3 BATHROOM PACKAGE			
DRAWN BY: LDS	DATE: 1/20/15	VIN/PART #	REV. STD PKG B
FILE NAME: S3-Wedge			
SCALE: 1:14	DATE PRINTED: 9/28/2015	SHEET 1 OF 5	

REV.	DESCRIPTION	DATE	APPROVED
B	MODIFIED UPPER CAB	4/28/2015	LDS
A	MODIFIED CABINETS	4/10/2015	LDS
REVISION TABLE			

DWG PATH: X:\Options\S-PKG\

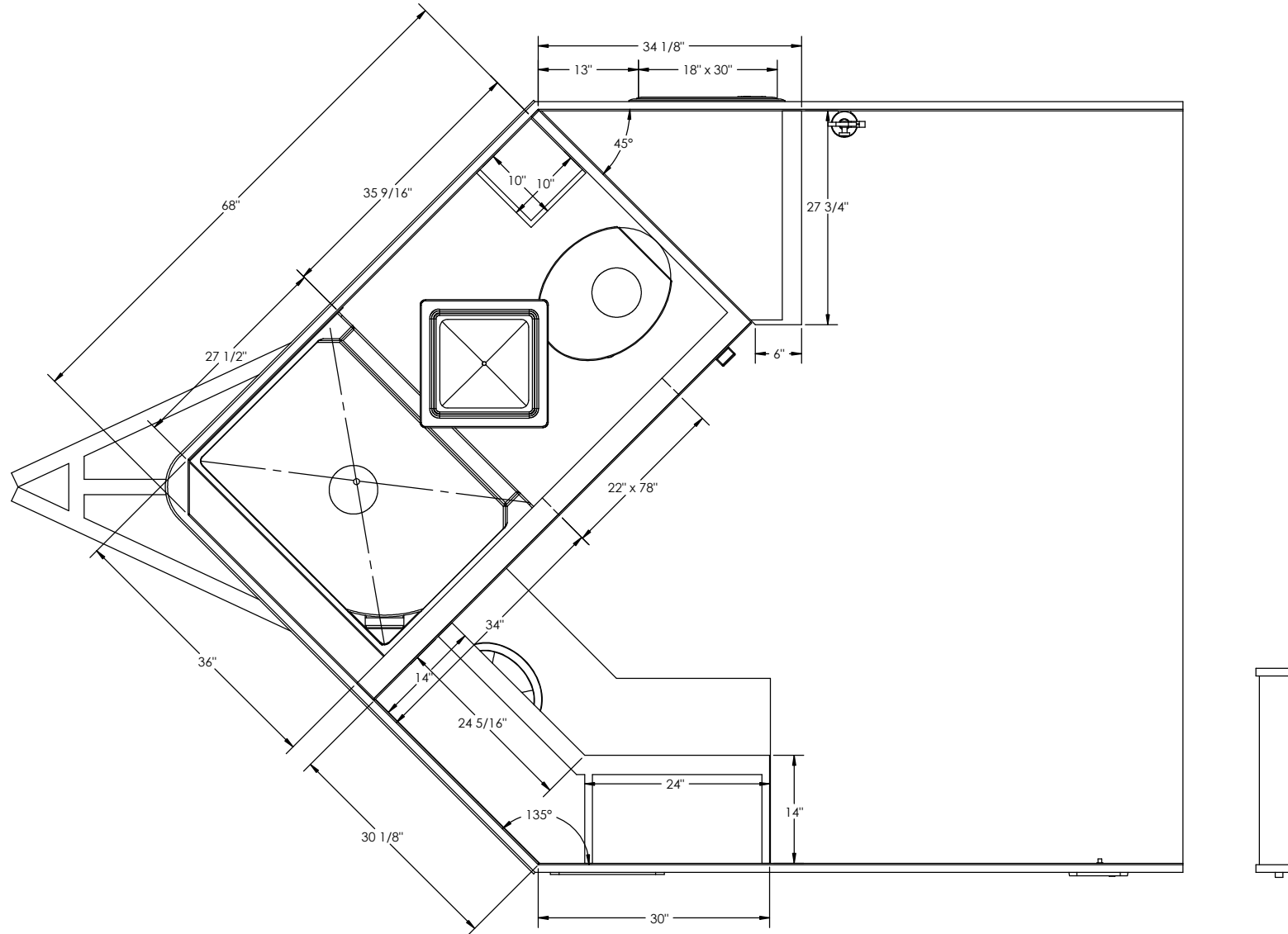

	TITLE: S3 BATHROOM PACKAGE			REV.
	DRAWN BY: LDS	DATE: 1/20/15	VIN/PART #	STD PKG B
	FILE NAME: S3-Wedge			
	SCALE: 1:10	DATE PRINTED: 9/28/2015	SHEET 2 OF 5	

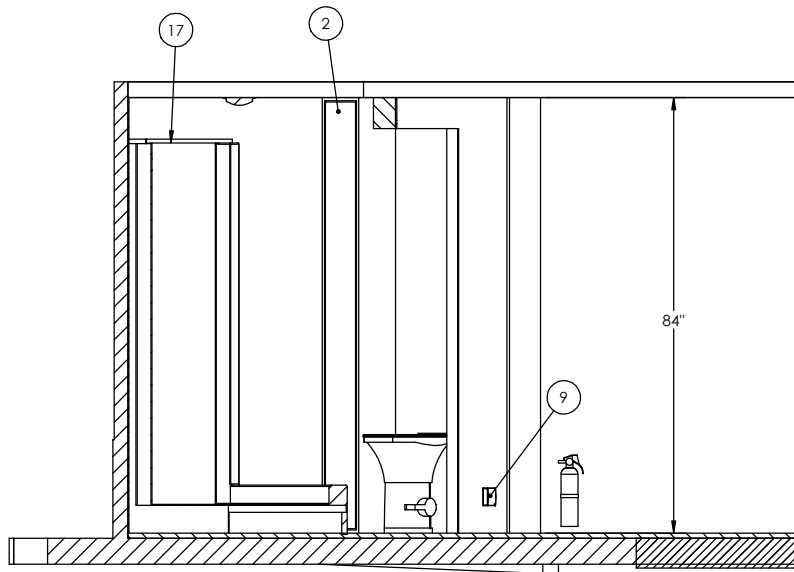

CURBSIDE INTERIOR
SECTION A-A

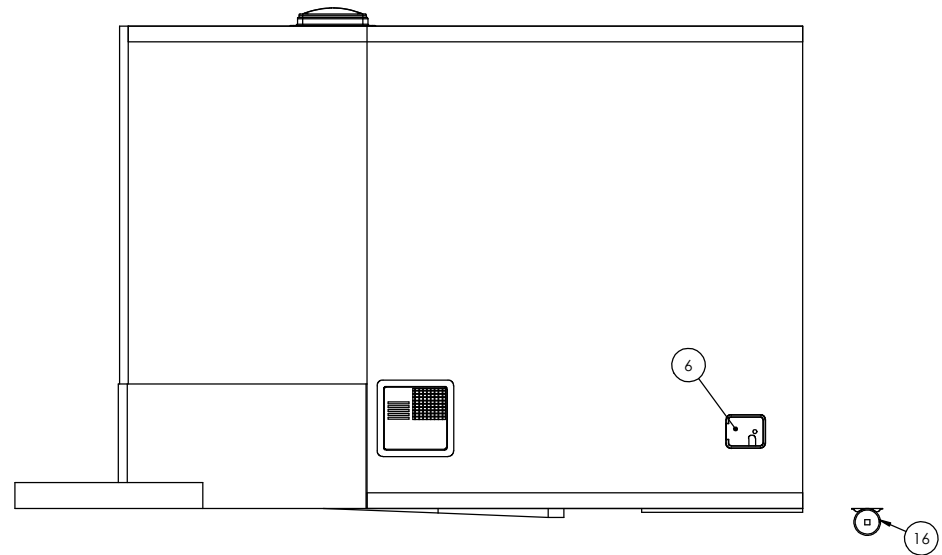

ROADSIDE EXTERIOR

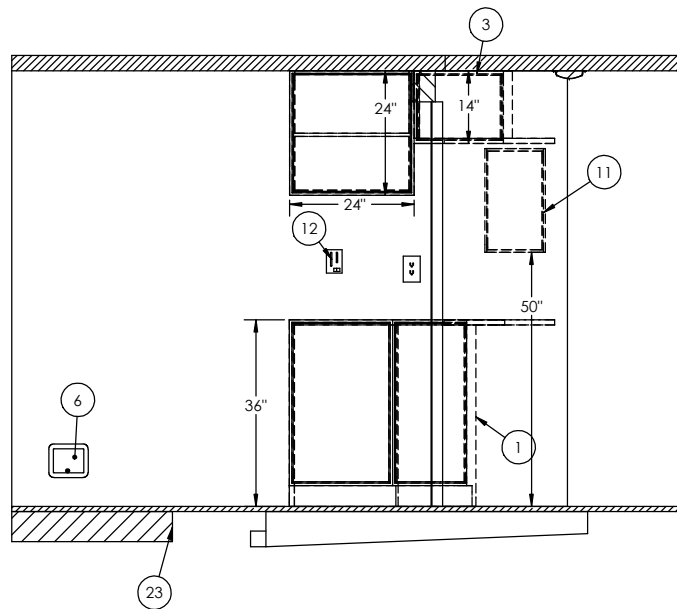

ROADSIDE INTERIOR
SECTION B-B

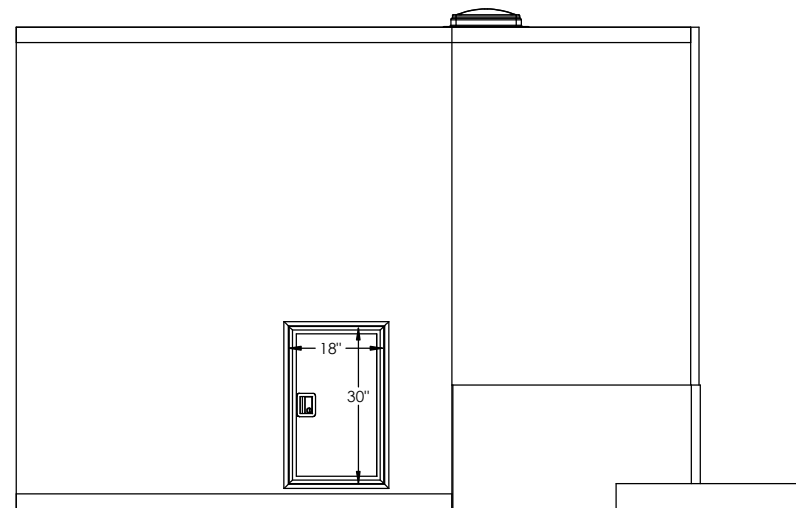

CURBSIDE EXTERIOR

		TITLE: S3 BATHROOM PACKAGE		
		DRAWN BY: LDS	DATE: 1/20/15	VIN/PART # STD PKG
FILE NAME: S3-Wedge				
SCALE: 1:18	DATE PRINTED: 9/28/2015	SHEET 3 OF 5		

OVERHEAD

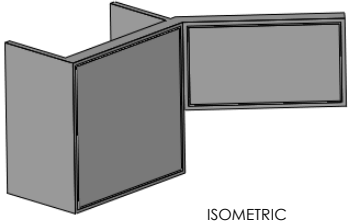

ISOMETRIC

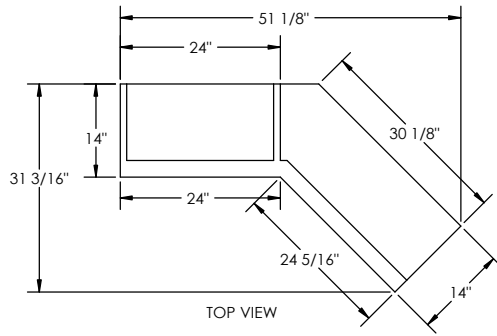

TOP VIEW

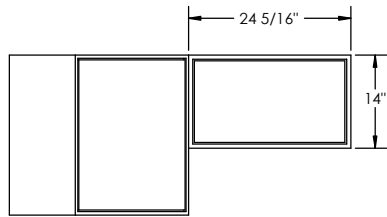

FRONT VIEW B

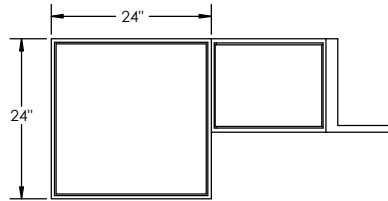

FRONT VIEW A

BASE

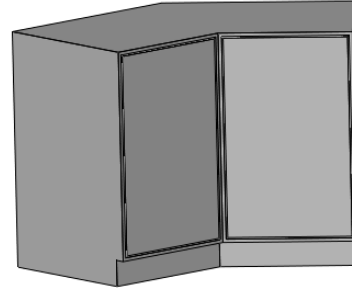

ISOMETRIC

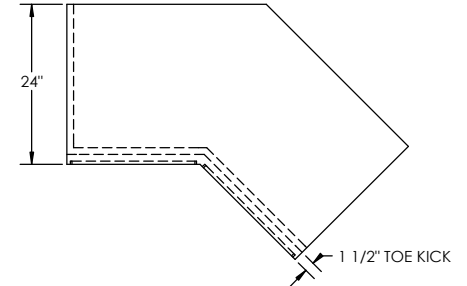

TOP VIEW

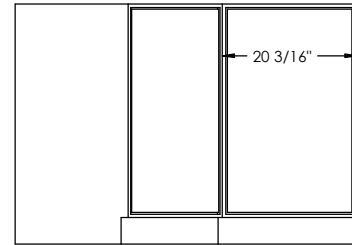

FRONT VIEW B

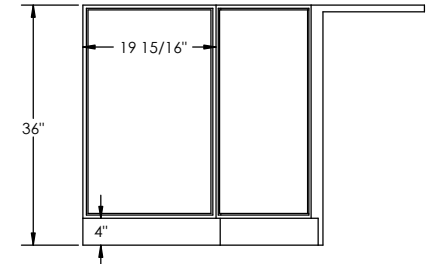

FRONT VIEW A

STORAGE CABINET

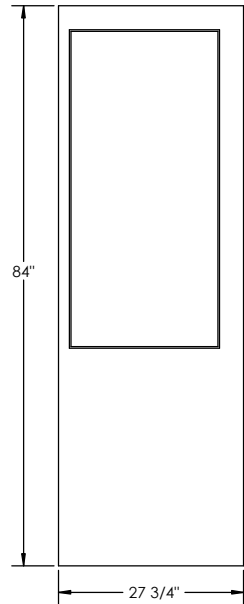

FRONT VIEW

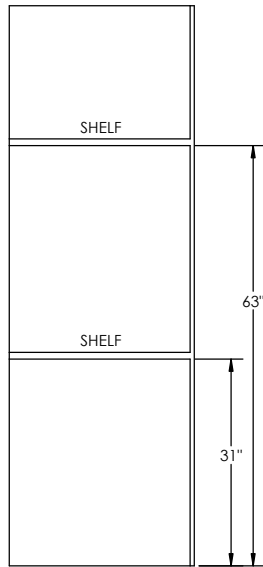

INSIDE (REAR) VIEW

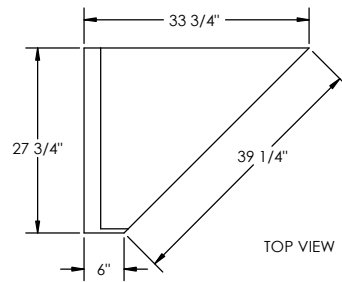

TOP VIEW

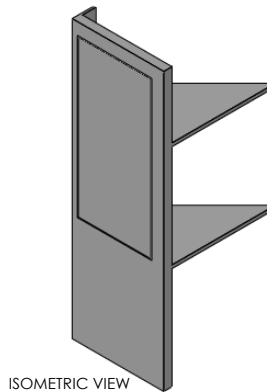

ISOMETRIC VIEW

LINEN

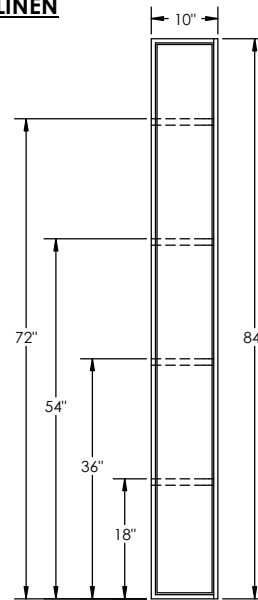

FRONT VIEW

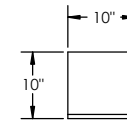

TOP VIEW



ISOMETRIC VIEW

				TITLE: S3 BATHROOM PACKAGE	
				DRAWN BY: LDS	DATE: 1/20/15
FILE NAME: CAB OVERHEAD S3-				SCALE: 1:14	
DATE PRINTED: 9/28/2015				SHEET 4 OF 5	

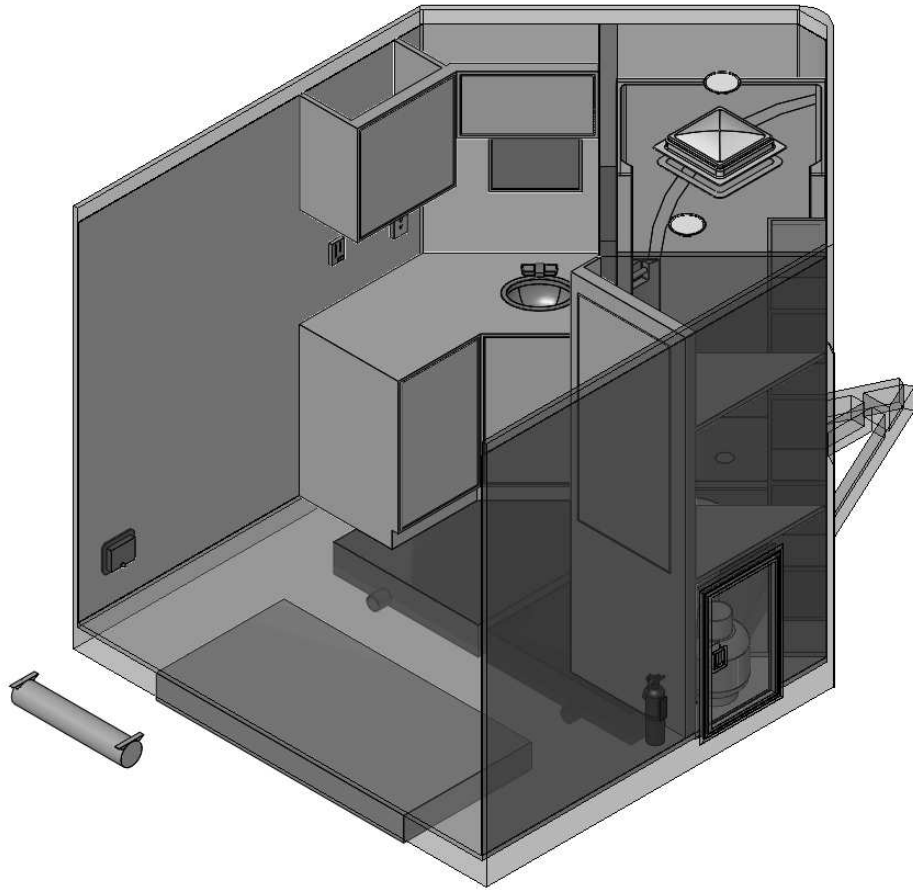

CURBSIDE VIEW

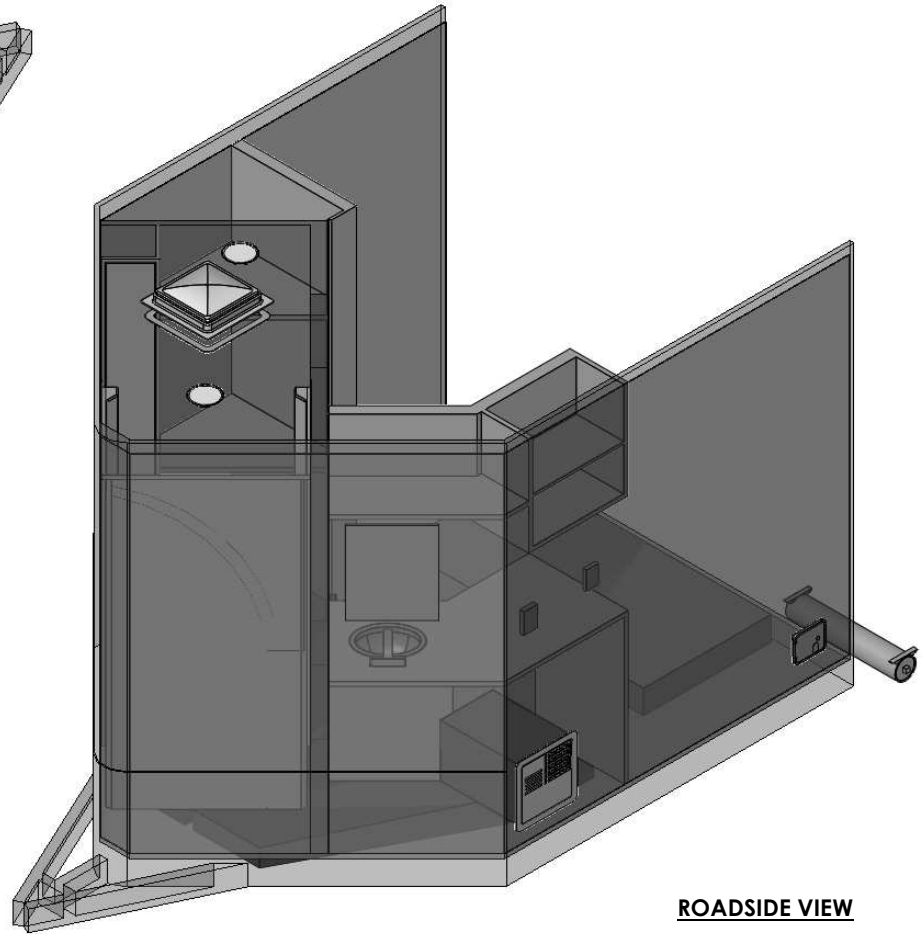

ROADSIDE VIEW

	TITLE: S3 BATHROOM PACKAGE			
	DRAWN BY: LDS	DATE: 1/20/15	VIN/PART #	REV. B
	FILE NAME: S3-Wedge			
	SCALE: 1:16	DATE PRINTED: 9/28/2015	SHEET 5 OF 5	