

BOM TABLE				
ITEM NO	PART NO	FILE NAME	DESCRIPTION	QTY
1		BATTERY	775 CCA IN BOX	1
2		CABINET, BASE T1		1
3		CABINET, CLOSET W-SHELVES T1		1
4		CABINET, MICRO OH		1
5		CABINET, OVERHEAD T1		1
6		COOK TOP, 2 BURNER	DROP-IN	1
7		COUNTERTOP, FLIP UP		1
8		FIRE EXTINGUISHER		1
9		FRIG	2.7 CU FT 3-WAY	1
10		HOOD, RANGE		1
11		LIGHT, CEILING - SURFACE MOUNT		2
12		LP DETECTOR		1
13		LP TANKS W-TRAY	20#	1
		LP TRAY		1
		LP TANK	20#	2
14		MICROWAVE, IN CABINET	Advent .9 cu ft	1
15		MIRROR		1
16		MONITOR PANEL, TANKS	3 TANK	1
17		MOTORBASE	30 AMP	1
18	11978	OUTLET, ELECTRICAL	120V 15A INTERIOR	3
19	11978	OUTLET, ELECTRICAL	120V 15A INT-DEDICATED	1
20		OUTLET, ELECTRICAL	120V 20A INT-DEDICATED	1
21		ROOF VENT	12V	1
22		SEWER HOSE COMP.		1
23		WATER HEATER, LP	6GAL	1
24		SHOWER	S-36 X 28 SHOWER	1
25		SINK, SINGLE BOWL SST	15 x 15 Single Bowl	1
26		TANK, WATER	48.5 GAL	1
27		TOILET		1
28		VENT, SALEM		1
29		WASTE TANK, CS TONGUE	42GAL - 21054	1
30		WASTE TANK, RS TONGUE	42GAL - 21053	1

ALL LOCATIONS ARE NOMINAL UNLESS CRITICAL DIMENSIONS ARE SPECIFICALLY NOTED

PROPRIETARY AND CONFIDENTIAL:
THE INFORMATION CONTAINED IN THIS DRAWING IS THE SOLE PROPERTY OF THE ALUMINUM TRAILER COMPANY. ANY REPRODUCTION IN PART OR AS A WHOLE WITHOUT THE WRITTEN PERMISSION OF THE ALUMINUM TRAILER COMPANY IS PROHIBITED.



TITLE:
T-1 PACKAGE

DRAWN BY: ATC DATE: 11/16/20 VIN/PART # REV.

FILE NAME: T1 SCALE:1:14 DATE PRINTED: 11/16/2020 SHEET 1 OF 4

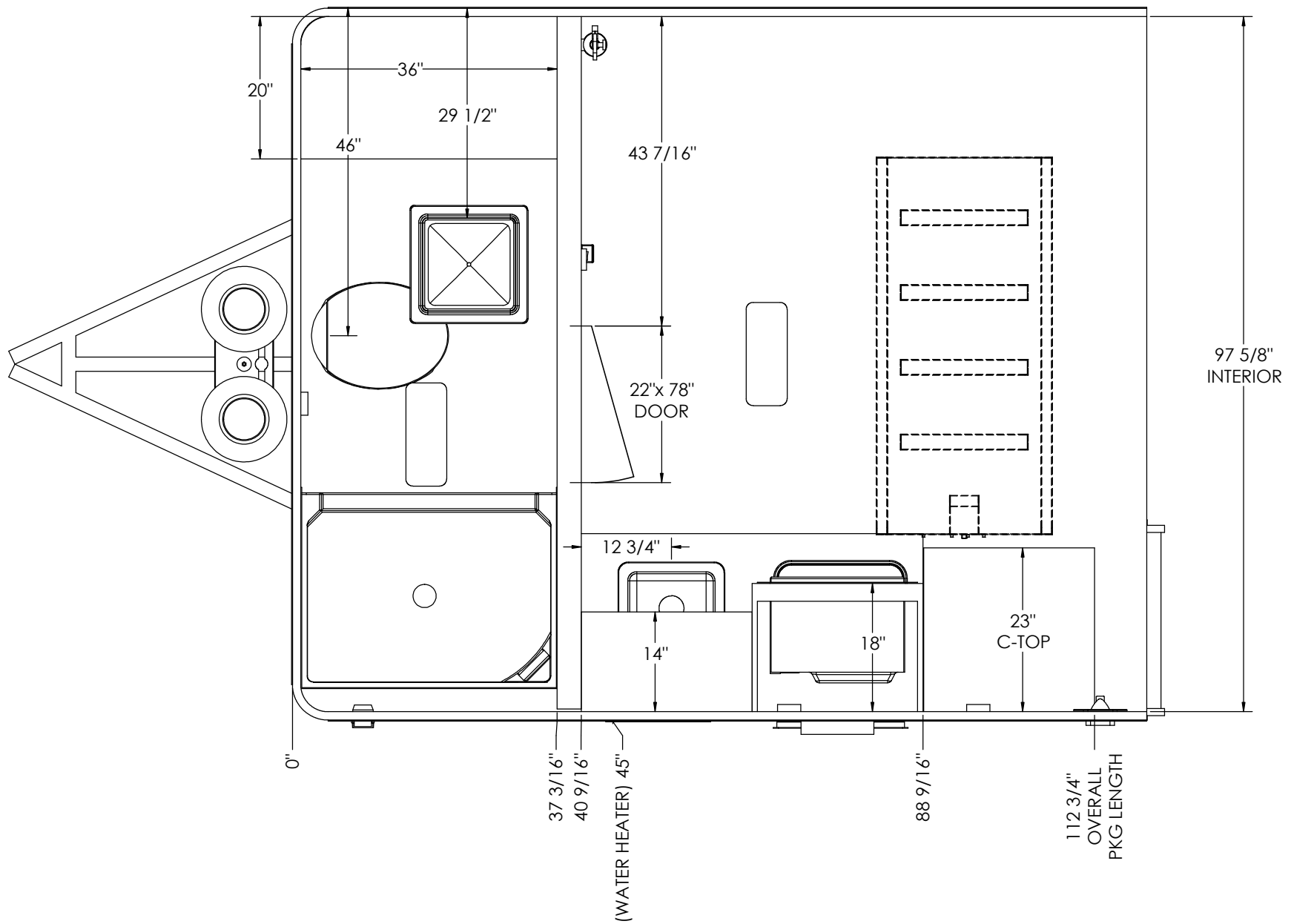

TITLE: T-1 PACKAGE			
DRAWN BY:	DATE: 11/16/20	VIN/PART #	REV.
FILE NAME: T1			
SCALE: 1:10	DATE PRINTED: 11/16/2020	SHEET 2 OF 4	

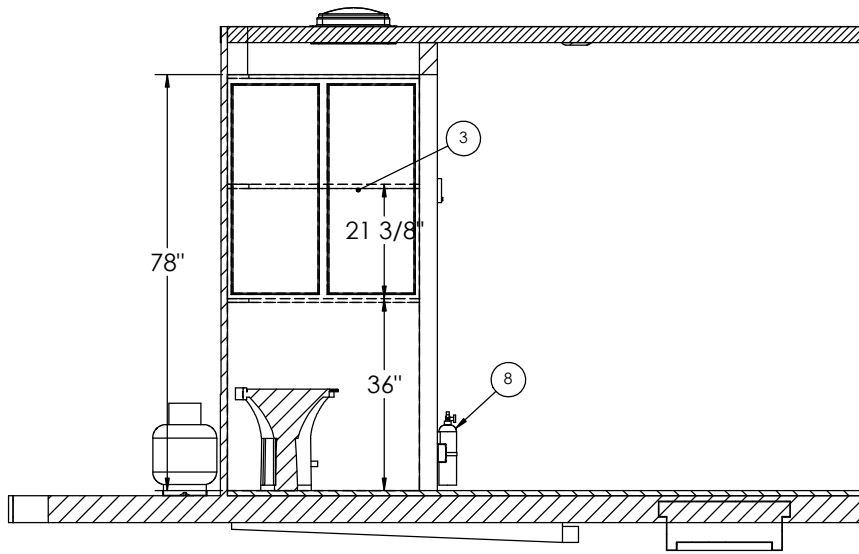

CURBSIDE INTERIOR
SECTION A-A

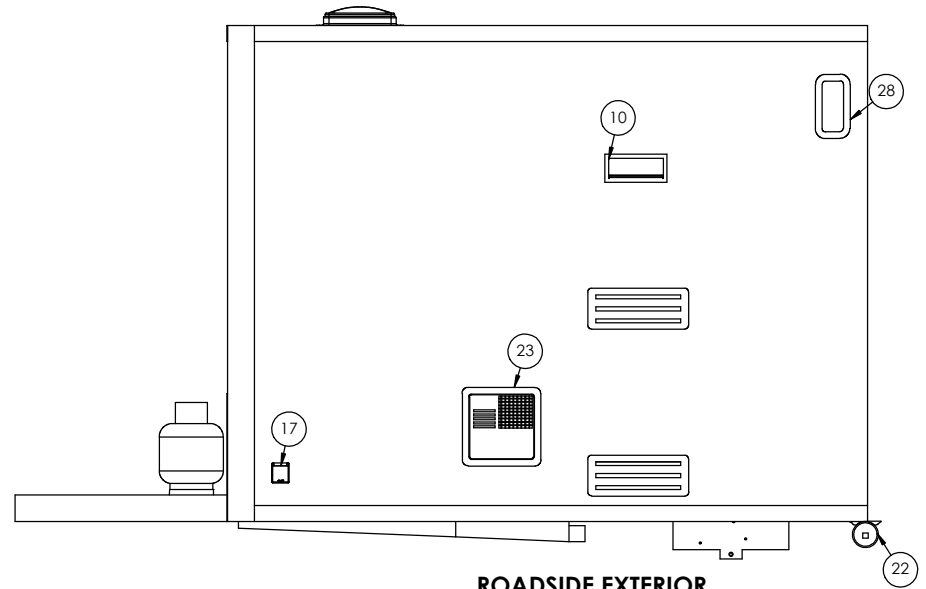

ROADSIDE EXTERIOR

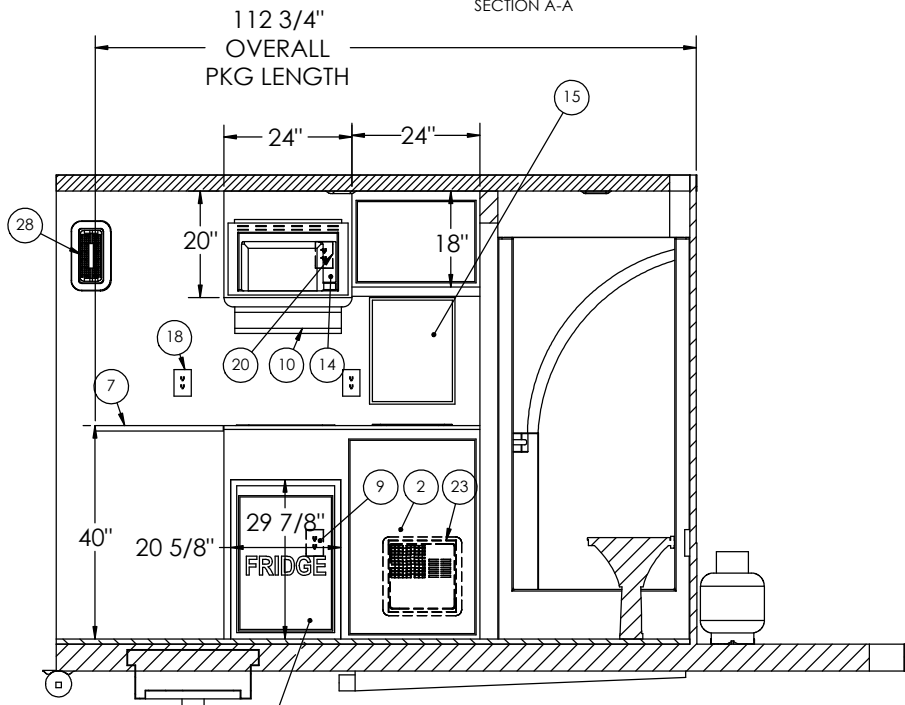

ROADSIDE INTERIOR
SECTION B-B

3-WAY FRIG REQUIRES
ENCLOSED CABINET

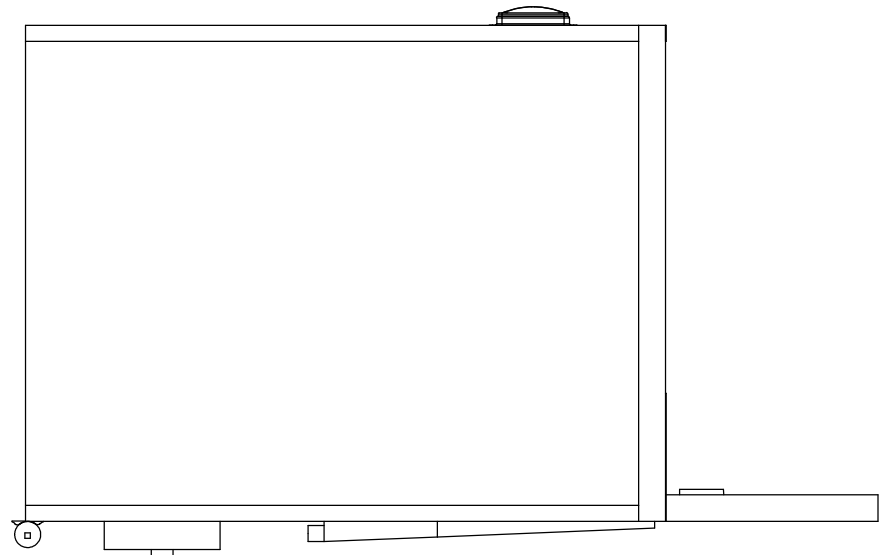

CURBSIDE EXTERIOR



TITLE: T-1 PACKAGE			
DRAWN BY:	DATE: 11/16/20	VIN/PART #	REV.
FILE NAME: T1			
SCALE: 1:18	DATE PRINTED: 11/16/2020	SHEET 3 OF 4	

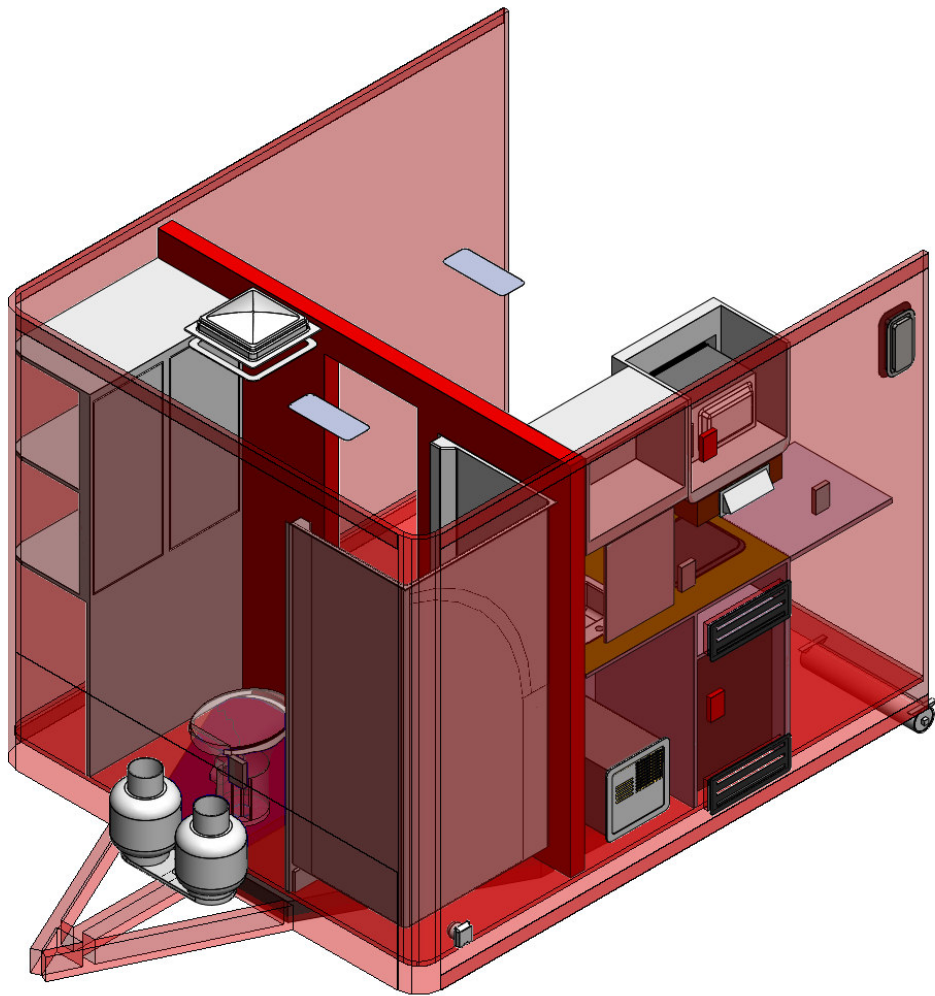

ROADSIDE

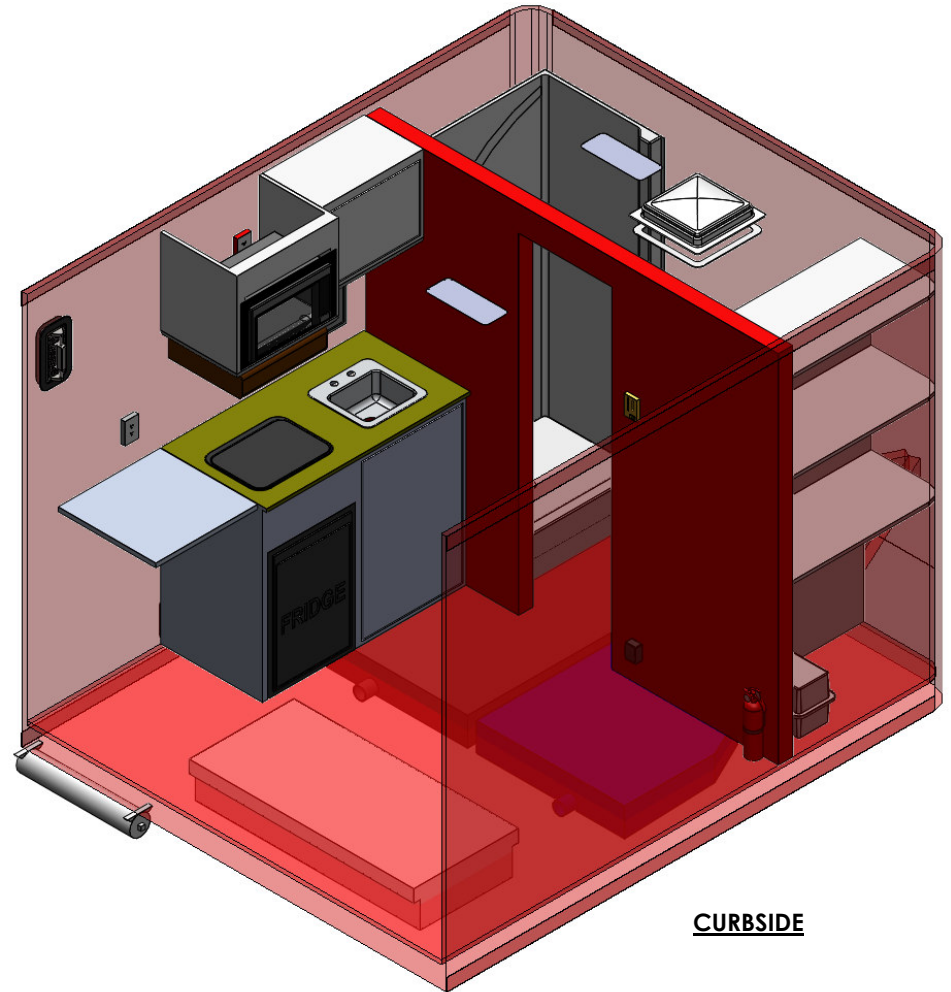

CURBSIDE



TITLE: T-1 PACKAGE			
DRAWN BY:	DATE: 11/16/20	VIN/PART #	REV.
FILE NAME: T1			
SCALE:1:16	DATE PRINTED: 11/16/2020	SHEET 4 OF 4	