

BOM TABLE				
ITEM NO	PART NO	FILE NAME	DESCRIPTION	QTY
1		BATTERY	775 CCA IN BOX	1
2		BREAKER BOX	30 AMP SERVICE	1
3		CABINET, BASE T2		1
4		CABINET, LINEN CLOSET S T-PKG		1
5		CABINET, OVERHEAD T2		1
6		CABINET, STORAGE T2		1
7		CONVERTER, 12VDC	55 AMP	1
8		COOK TOP, 2 BURNER	DROP-IN	1
9		COUNTERTOP, FLIP UP		1
10		FILL, WATER	City+Gravity	1
11		FIRE EXTINGUISHER		1
12		FRIG	2.7 CU FT 3-WAY	1
13		HOOD, RANGE		1
14		LIGHT, CEILING - SURFACE MOUNT		2
15		LP DETECTOR		1
16		LP TANKS W-TRAY	20#	1
		LP TRAY		1
		LP TANK	20#	2
17		MICROWAVE, IN CABINET	CONTOURE 1.0 900w	1
18		MIRROR		1
19		MONITOR PANEL, TANKS	3 TANK	1
20		MOTORBASE	30 AMP	1
21	11978	OUTLET, ELECTRICAL	120V 15A INTERIOR	3
22	11978	OUTLET, ELECTRICAL	120V 15A INT-DEDICATED	1
23		OUTLET, ELECTRICAL	120V 20A INT-DEDICATED	1
24		PARTITION WALL S T-PKG		1
25		ROOF VENT	12V	1
26		SEWER HOSE COMP.		1
27		SHELF, VANITY		1
28		SHOWER	S-36 X 28 SHOWER	1
29		SINK, SINGLE BOWL SST	15 x 15 Single Bowl	1
30		TANK, WATER	48.5 GAL	1
31		TOILET		1
32		VENT, SALEM		1
33		WASTE TANK, CS TONGUE	42GAL - 21054	1
34		WASTE TANK, RS TONGUE	42GAL - 21053	1
35		WATER HEATER, LP	6GAL	1

ALL LOCATIONS ARE NOMINAL UNLESS CRITICAL DIMENSIONS ARE SPECIFICALLY NOTED

PROPRIETARY AND CONFIDENTIAL:
 THE INFORMATION CONTAINED IN THIS DRAWING IS THE SOLE PROPERTY OF THE ALUMINUM TRAILER COMPANY. ANY REPRODUCTION IN PART OR AS A WHOLE WITHOUT THE WRITTEN PERMISSION OF THE ALUMINUM TRAILER COMPANY IS PROHIBITED.



TITLE: T2 PACKAGE			
DRAWN BY: ATC	DATE: 11/16/20	VIN/PART #	REV.
FILE NAME: T2			
SCALE: 1:14	DATE PRINTED: 11/16/2020	SHEET 1 OF 5	

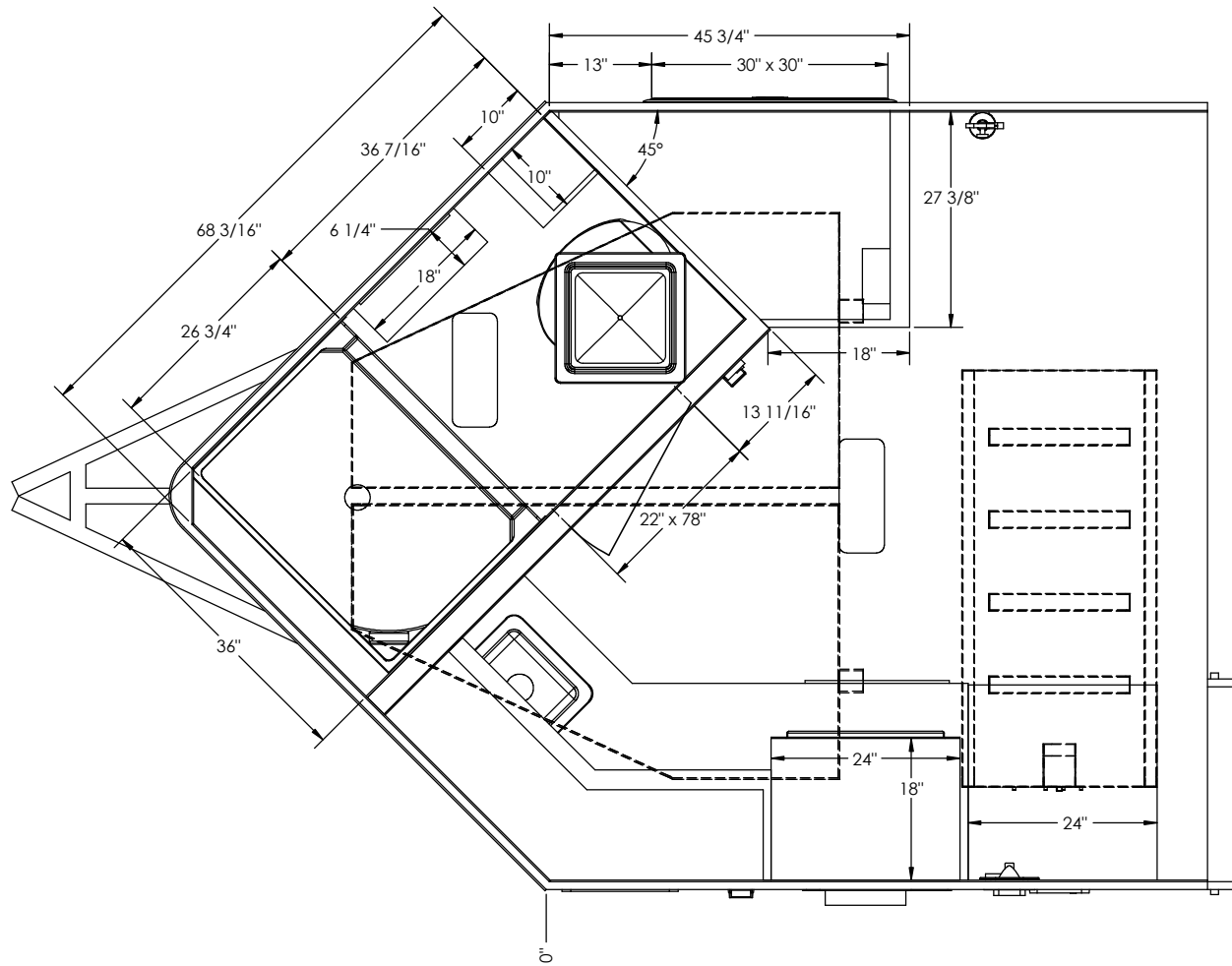

TITLE: T2 PACKAGE			
DRAWN BY:	DATE: 11/16/20	VIN/PART #	REV.
FILE NAME: T2			
SCALE: 1:12	DATE PRINTED: 11/16/2020	SHEET 2 OF 5	

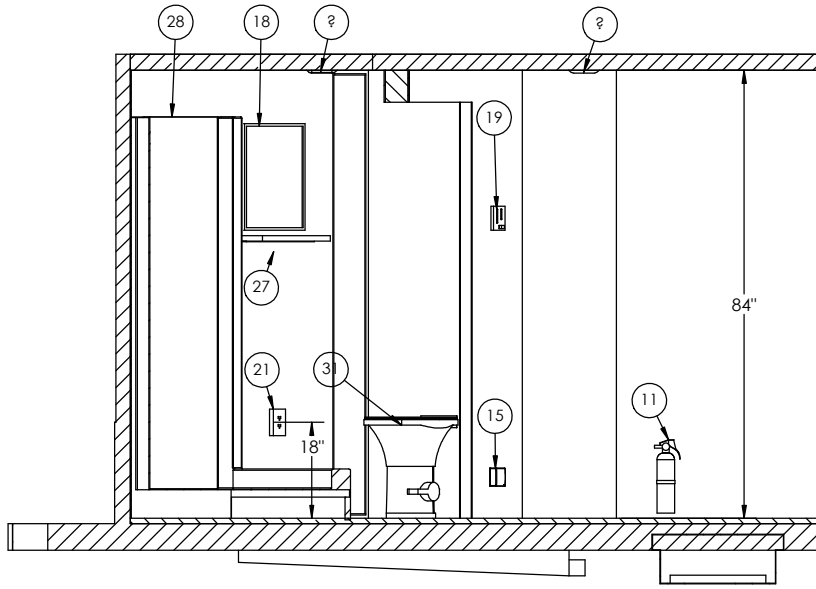

CURBSIDE INTERIOR
SECTION A-A

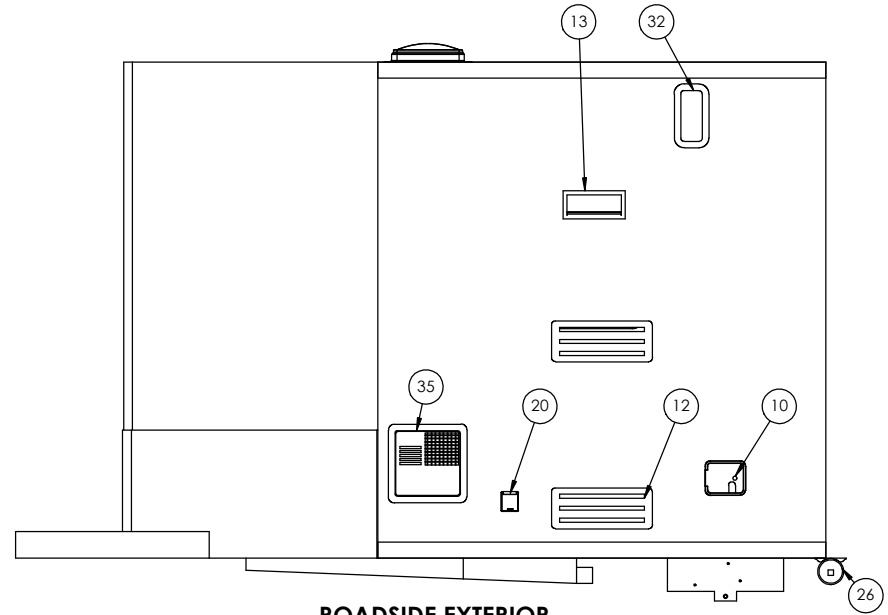

ROADSIDE EXTERIOR

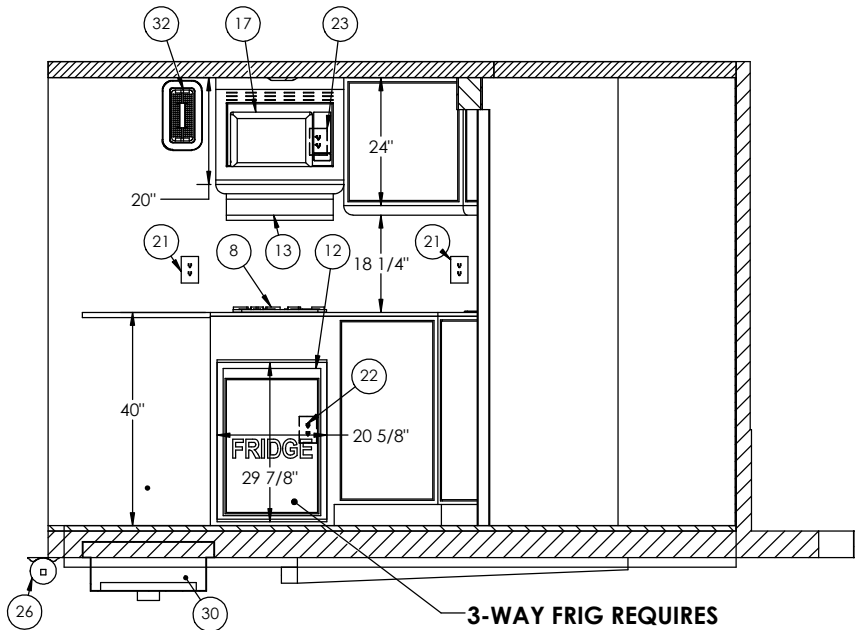

ROADSIDE INTERIOR
SECTION B-B

3-WAY FRIG REQUIRES ENCLOSED CABINET

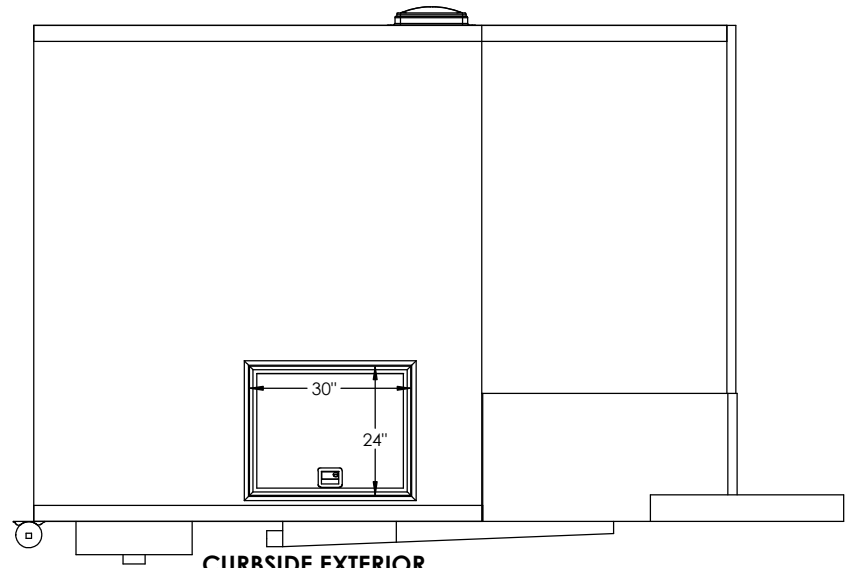

CURBSIDE EXTERIOR

	TITLE: T2 PACKAGE		
	DRAWN BY:	DATE: 11/16/20	VIN/PART #
	FILE NAME: T2	SCALE: 1:18	DATE PRINTED: 11/16/2020
			REV.
			SHEET 3 OF 5

OVERHEAD

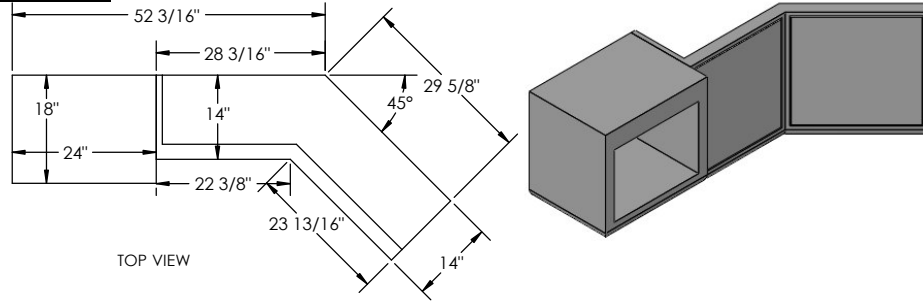

TOP VIEW

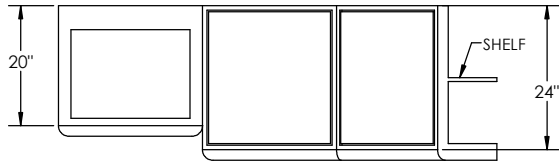

FRONT VIEW

BASE

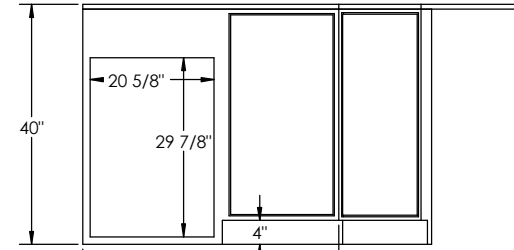
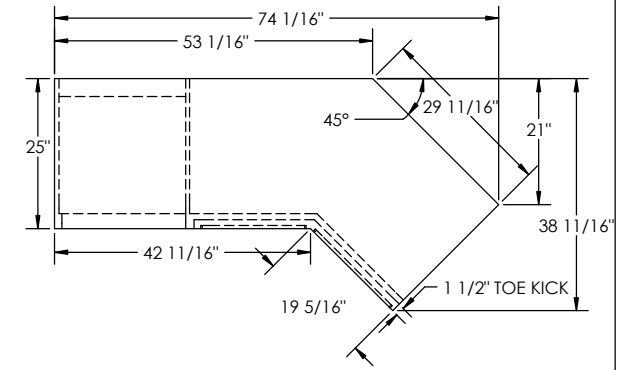
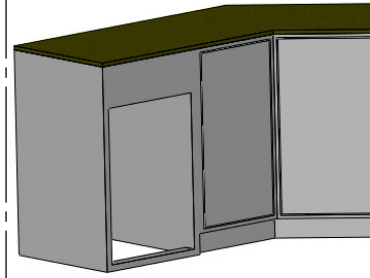

FRONT VIEW A

STORAGE CABINET

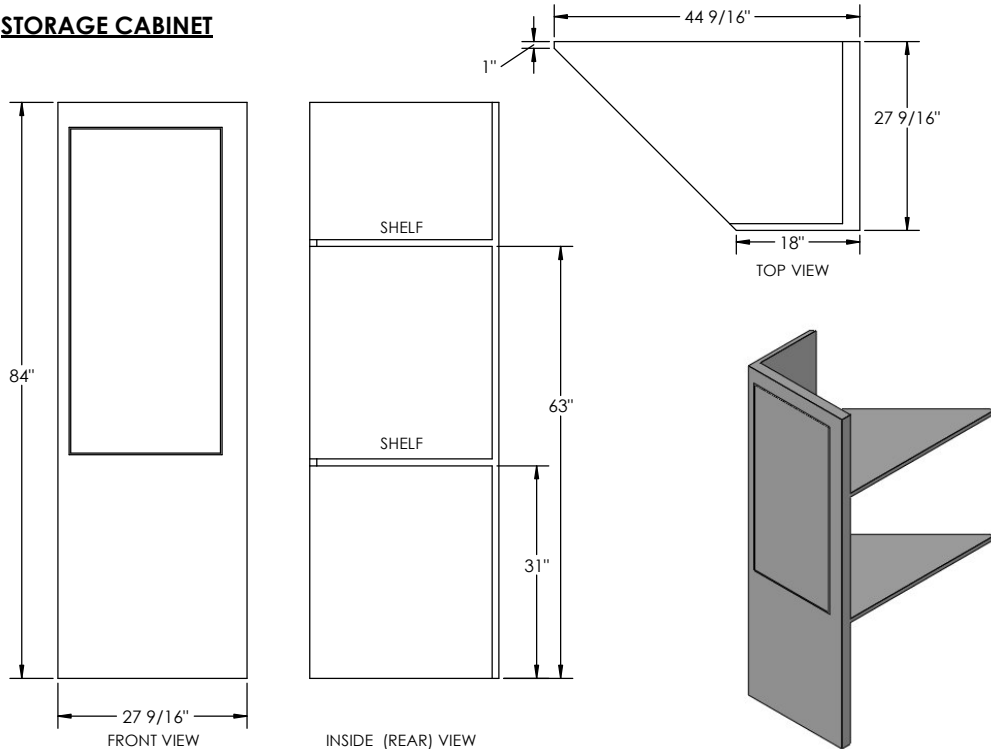

84"

FRONT VIEW

INSIDE (REAR) VIEW

TOP VIEW

LINEN

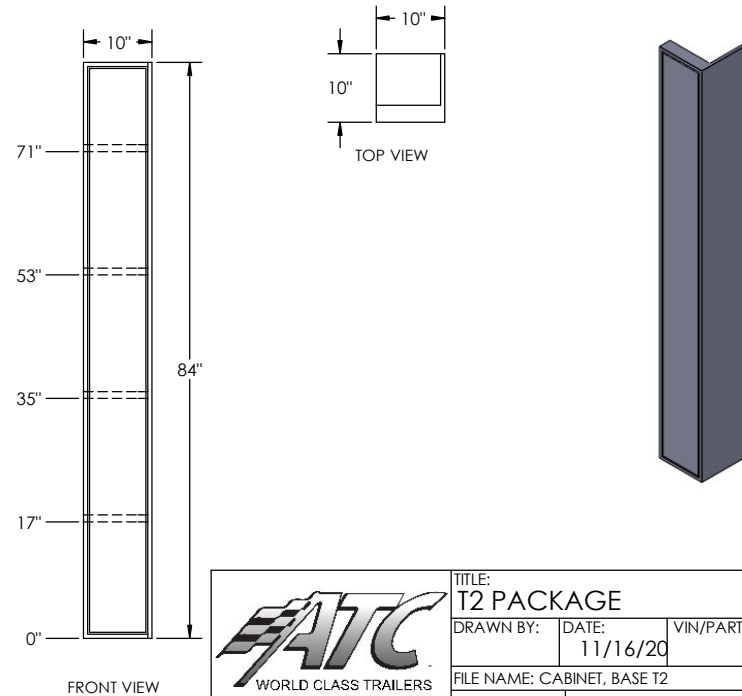

71"

53"

35"

17"

0"

FRONT VIEW

TOP VIEW



TITLE: T2 PACKAGE			
DRAWN BY:	DATE: 11/16/20	VIN/PART #	REV.
FILE NAME: CABINET, BASE T2			
SCALE:1:14	DATE PRINTED: 11/16/2020	SHEET 4 OF 5	

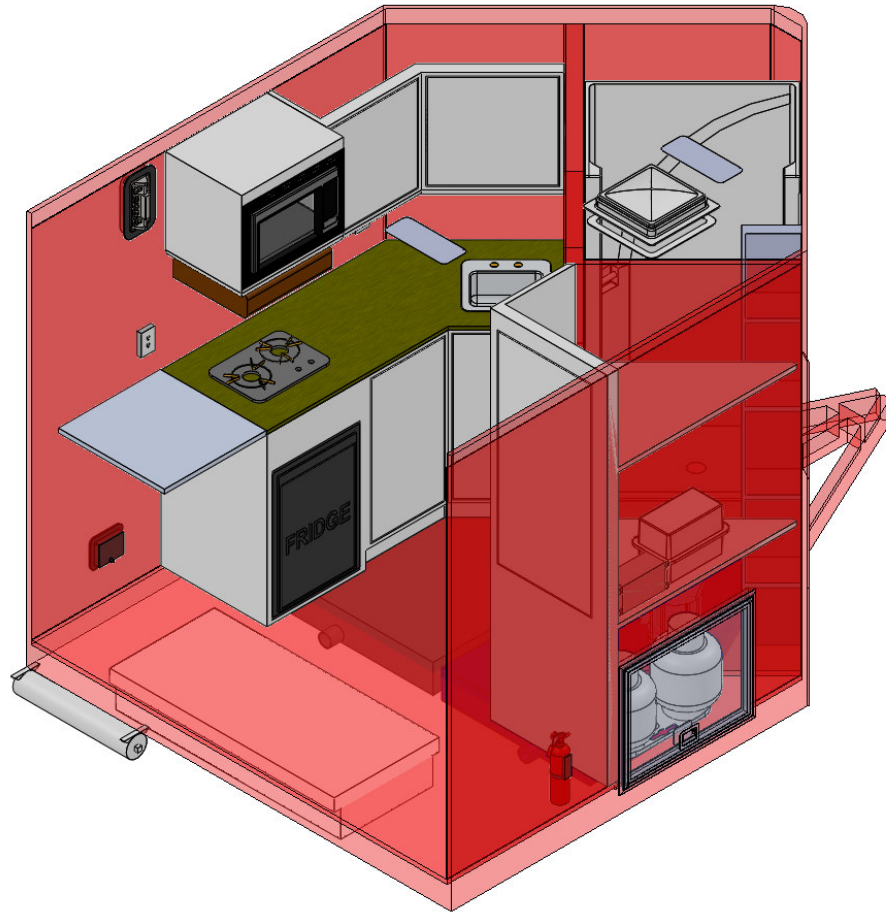

CURB SIDE VIEW

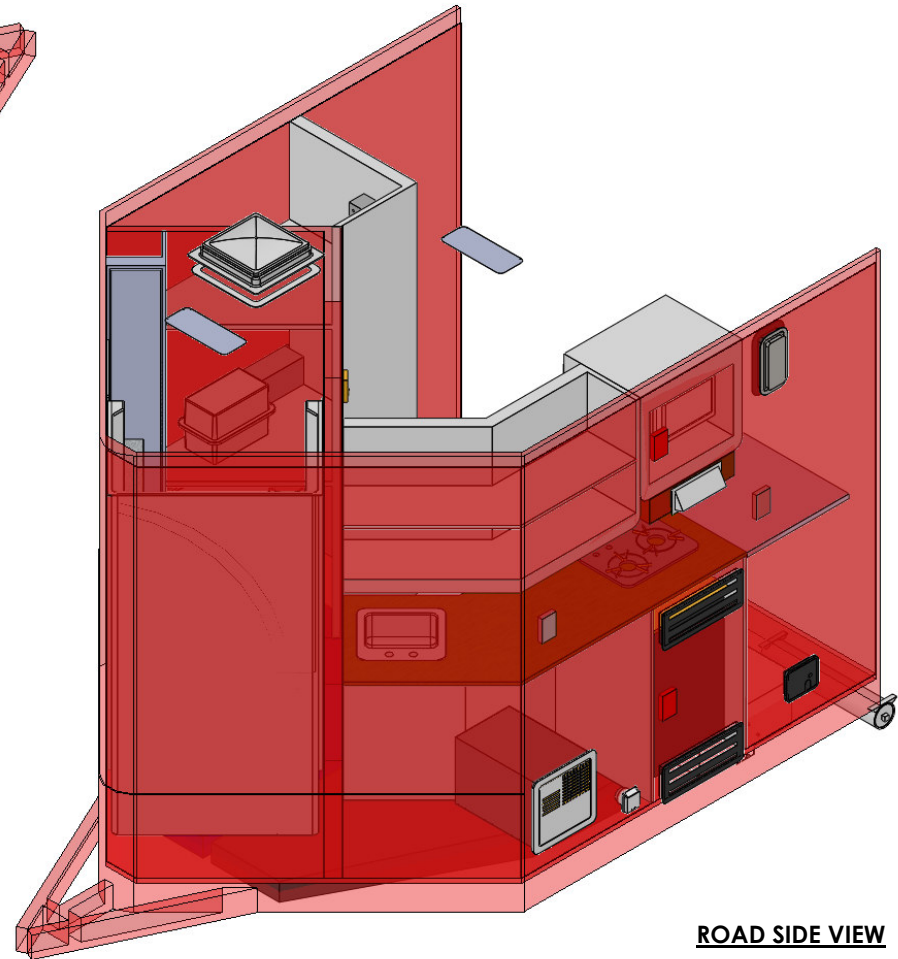

ROAD SIDE VIEW



TITLE: T2 PACKAGE			
DRAWN BY:	DATE:	VIN/PART #	REV.
	11/16/20		
FILE NAME: T2			
SCALE:1:16	DATE PRINTED: 11/16/2020	SHEET 5 OF 5	