

BOM TABLE				
ITEM NO	PART NO	FILE NAME	DESCRIPTION	QTY
1		CAB STORAGE S-PKG		1
2		CABINET LAV BASE S2		1
3		CABINET, LINEN CLOSET S2		1
4	20064	FILL, WATER	City+Gravity	1
5	12265	LIGHT, DOME	SURFACE MOUNT	2
6		MIRROR	12" x 18"	1
7	26281-w/12498-b	MONITOR PANEL, TANKS	2 TANK	1
8	11978	OUTLET, ELECTRICAL	120V 15A INTERIOR	1
9		PARTITION WALL S-PKG		1
10	13849	SEWER HOSE COMP.		1
11	37019	TOILET		1
12		WASTE TANK, CS TONGUE	42GAL - 21054	1
13	14119	WATER TANK	W0926 42 GAL	1
14	14618	ROOF VENT	12V	1
15	13798	SINK, OVAL SST 13.25 x 10.5 x 5		1

ALL LOCATIONS ARE NOMINAL UNLESS CRITICAL DIMENSIONS ARE SPECIFICALLY NOTED

PROPRIETARY AND CONFIDENTIAL:
THE INFORMATION CONTAINED IN THIS DRAWING IS THE SOLE PROPERTY OF THE ALUMINUM TRAILER COMPANY. ANY REPRODUCTION IN PART OR AS A WHOLE WITHOUT THE WRITTEN PERMISSION OF THE ALUMINUM TRAILER COMPANY IS PROHIBITED.



TITLE:
S2 BATHROOM PACKAGE

DRAWN BY: LDS	DATE: 1/20/15	VIN/PART #	REV. STD PKG A
------------------	------------------	------------	--------------------------

FILE NAME: S2-Wedge	SCALE: 1:14	DATE PRINTED: 7/21/2015	SHEET 1 OF 4
---------------------	-------------	-------------------------	--------------

REV.	DESCRIPTION	DATE	APPROVED
A	CHANGED LINEN CLOSET; RENAMED VANITY CAB	1/27/2015	LDS
REVISION TABLE			

DWG PATH: X:\Options\S-PKG\

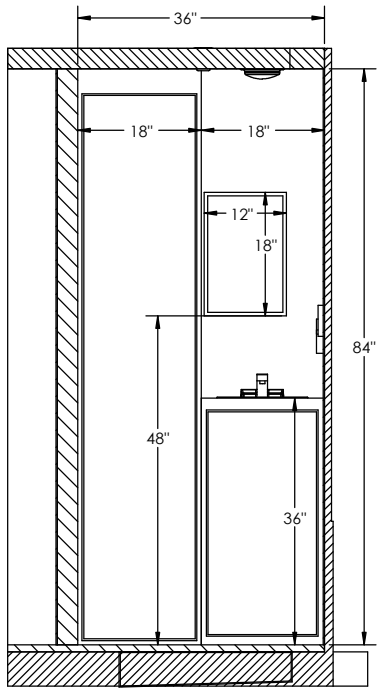
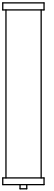
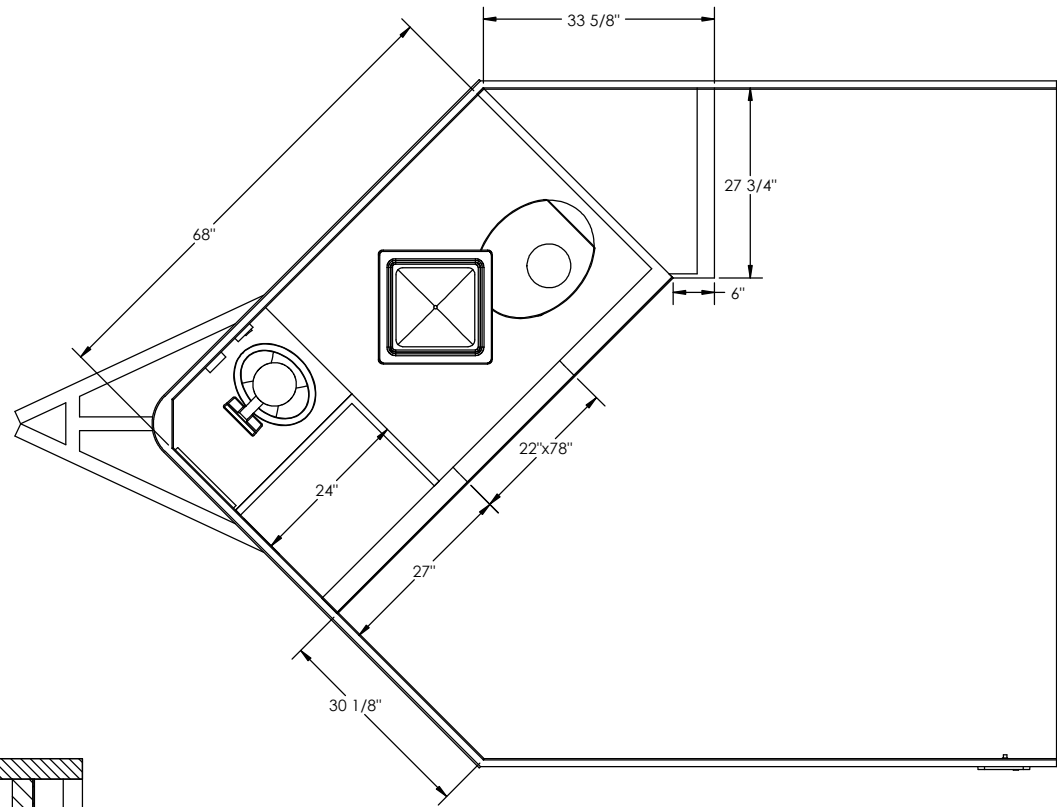

SECTION A-A

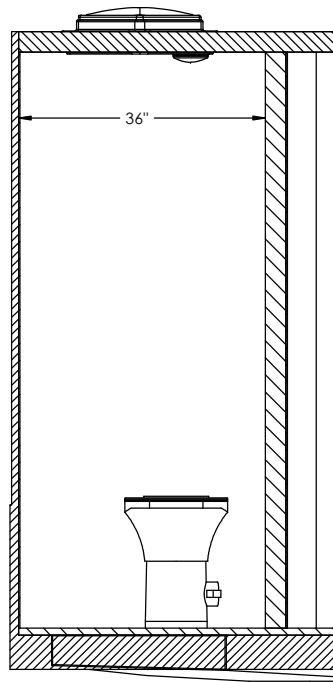

SECTION B-B



TITLE: S2 BATHROOM PACKAGE			
DRAWN BY: LDS	DATE: 1/20/15	VIN/PART #	REV. A
FILE NAME: S2-Wedge		STD PKG	
SCALE: 1:14	DATE PRINTED: 7/21/2015	SHEET 2 OF 4	

VANITY

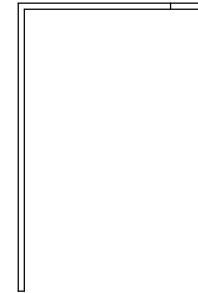
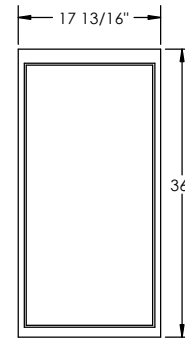
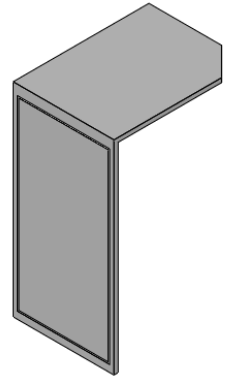
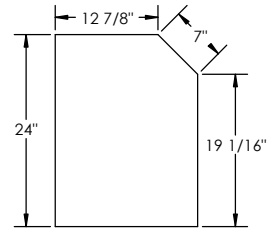

SIDE VIEW

STORAGE CABINET

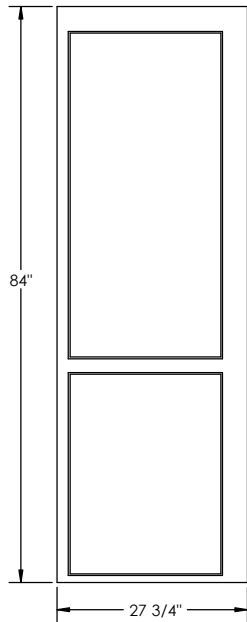

FRONT VIEW

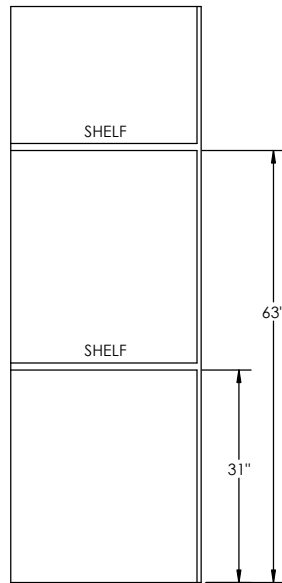

INSIDE (REAR) VIEW

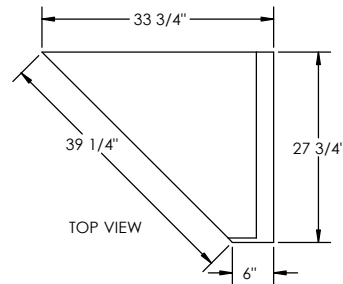

TOP VIEW

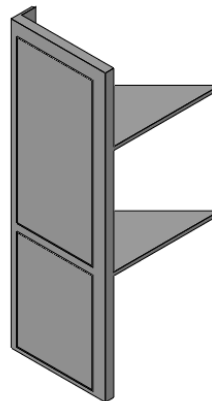

LINEN CLOSET



TOP VIEW

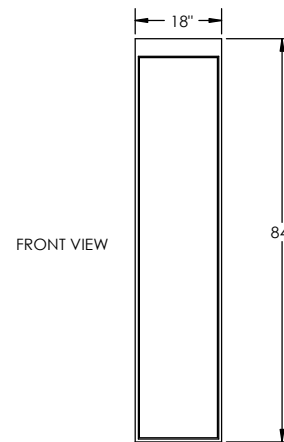

FRONT VIEW

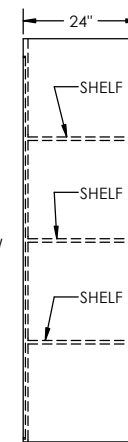

SIDE VIEW

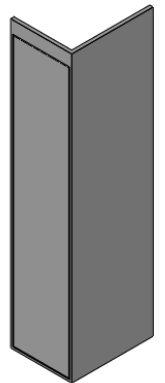

TITLE: S2 BATHROOM PACKAGE			
DRAWN BY: LDS	DATE: 1/20/15	VIN/PART #	REV. A
FILE NAME: CAB STORAGE S-PKG			
SCALE: 1:14	DATE PRINTED: 7/21/2015	SHEET 3 OF 4	

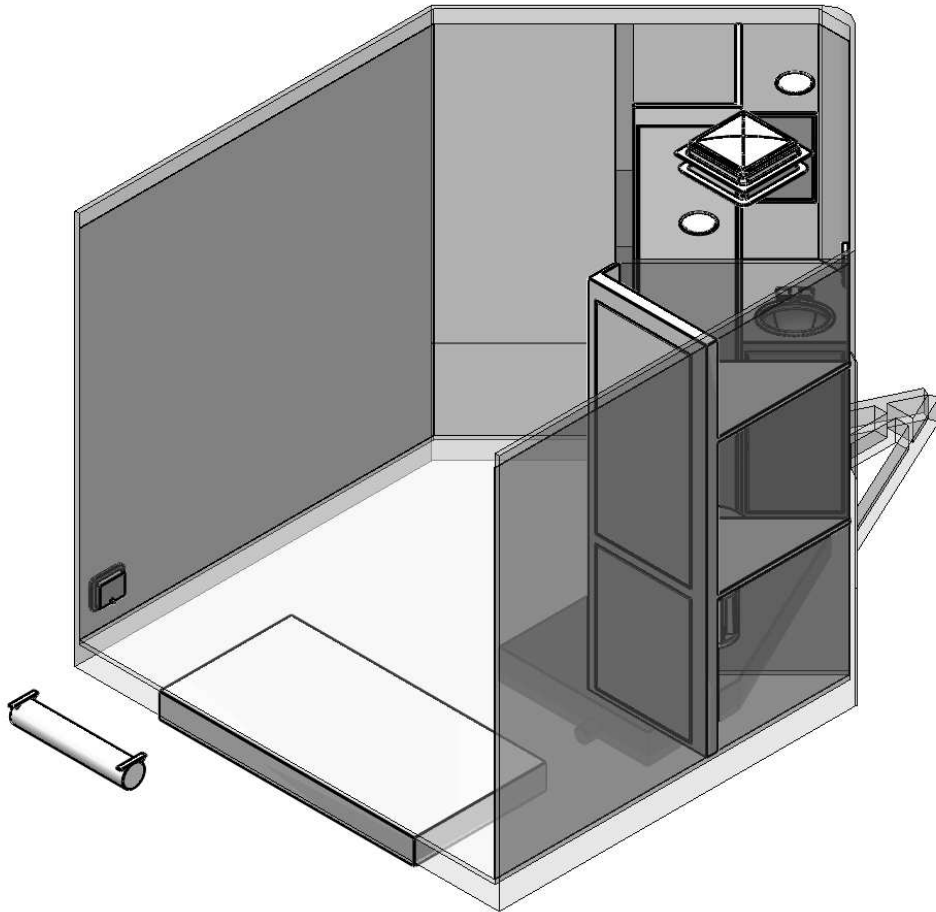

CURBSIDE VIEW

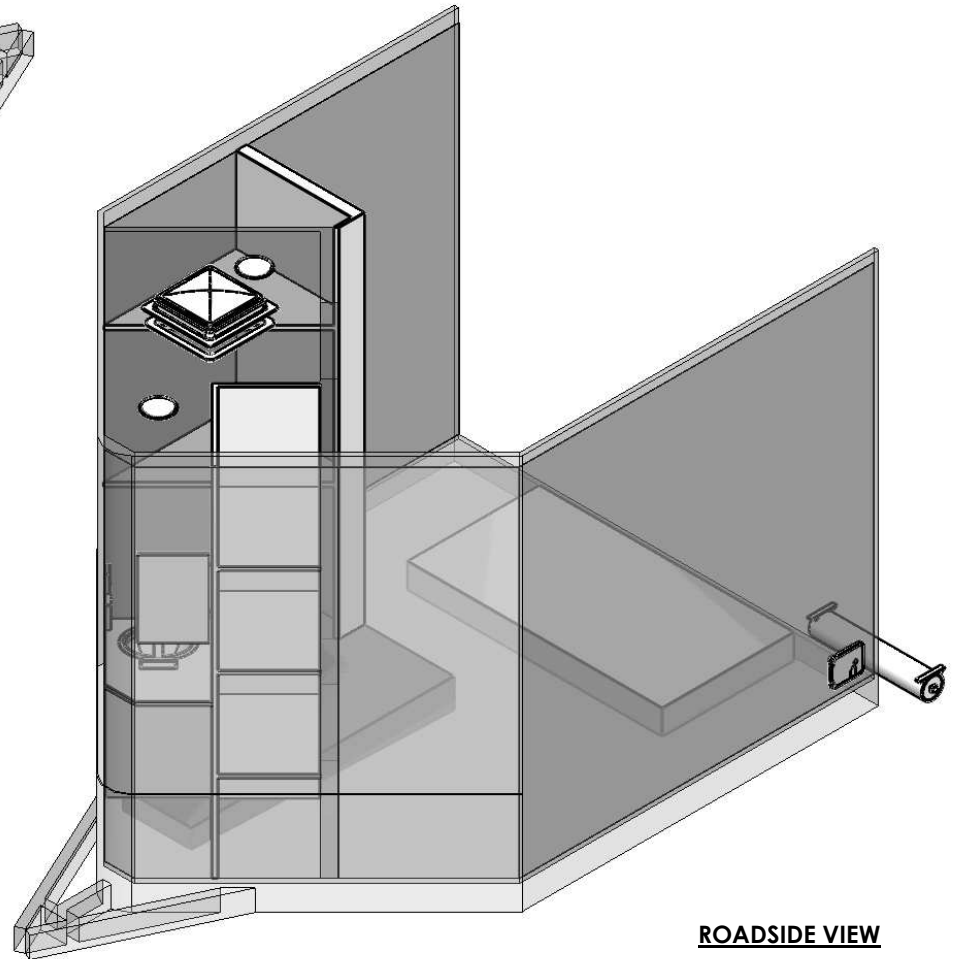

ROADSIDE VIEW



TITLE: S2 BATHROOM PACKAGE			
DRAWN BY: LDS	DATE: 1/20/15	VIN/PART # STD PKG	REV. A
FILE NAME: S2-Wedge			
SCALE:1:16	DATE PRINTED: 7/21/2015	SHEET 4 OF 4	